

WV 570
WVD 570

WV 900
WVD 900

WV 750
WV 750T
WVD 750
WVD 750T

WVD 1800-DH
WVD 1800-PH
WVD 1800-AP

Numatic

numatic.com

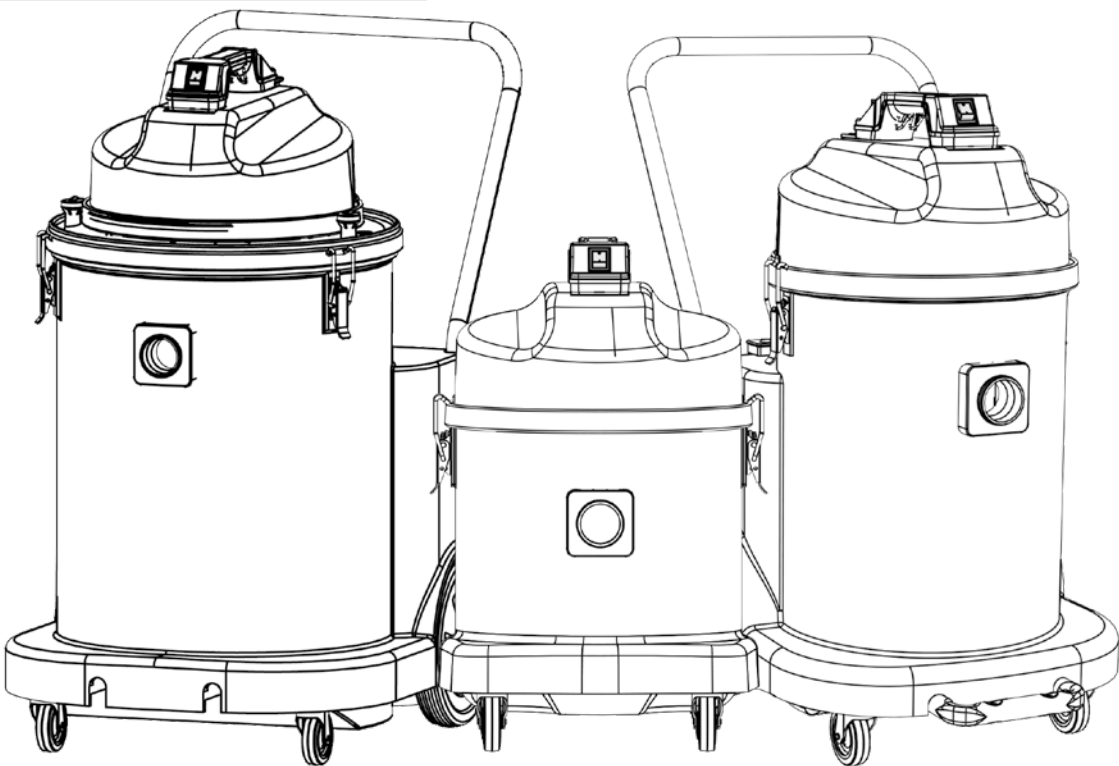

Original Instructions

CAUTION, Read the Instructions before using the machine.

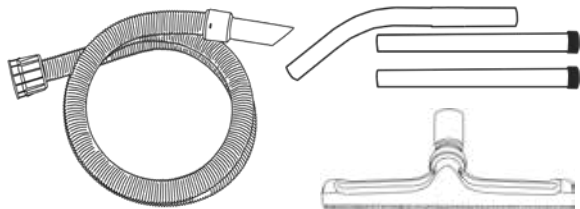

BS7
WVD1800DH
WVD1800PH
WVD1800AP

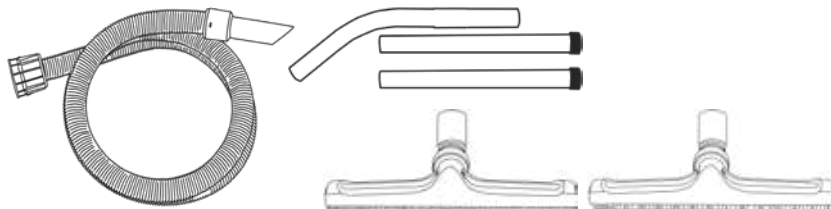

BS8
WV570
WVD570
WV900
WVD900

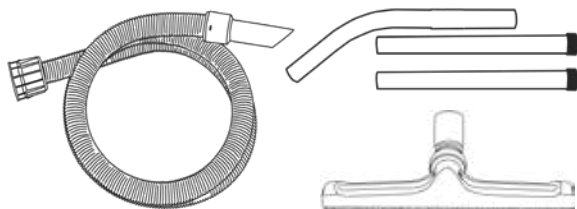

AS15
WV900

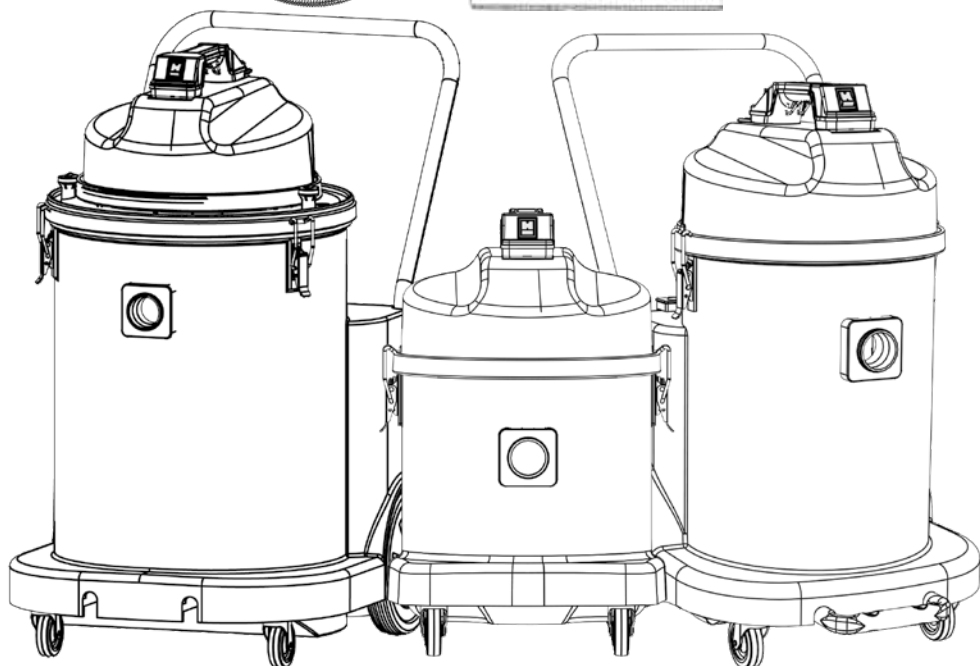

WV 900 WVD900

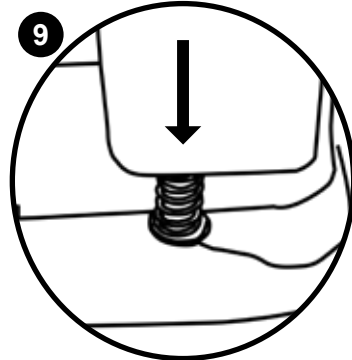
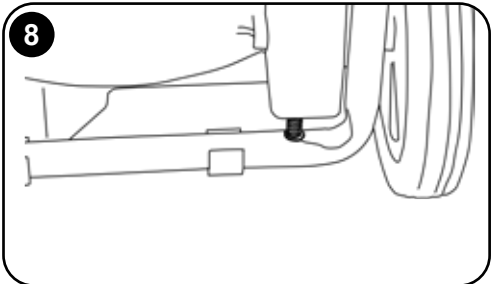
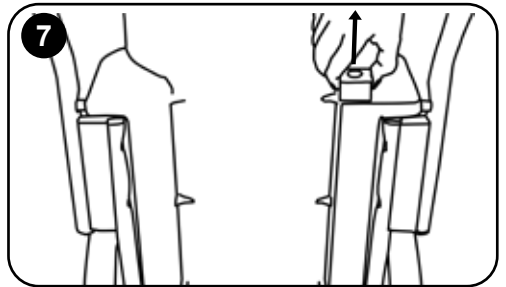
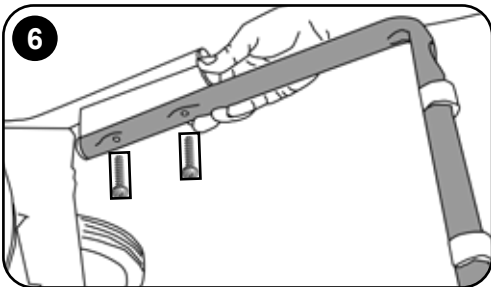
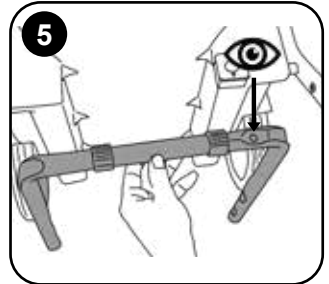
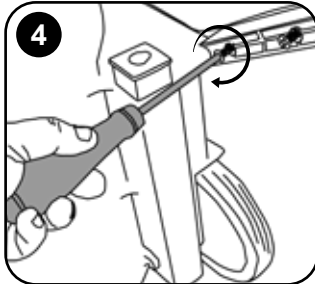
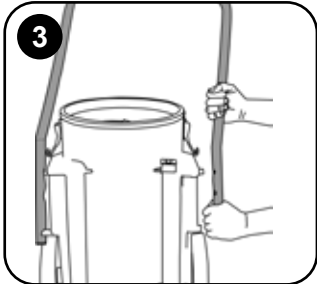
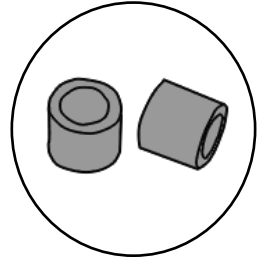
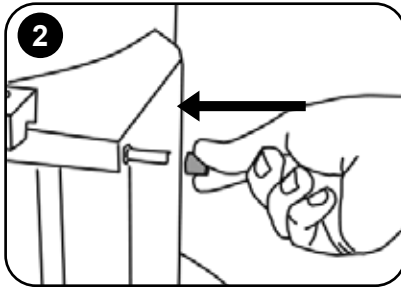
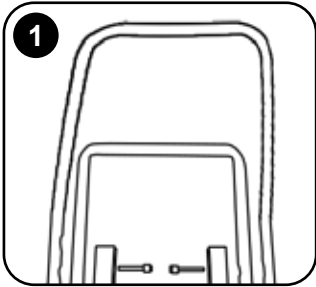

Wet - Assembling the machine for extraction use

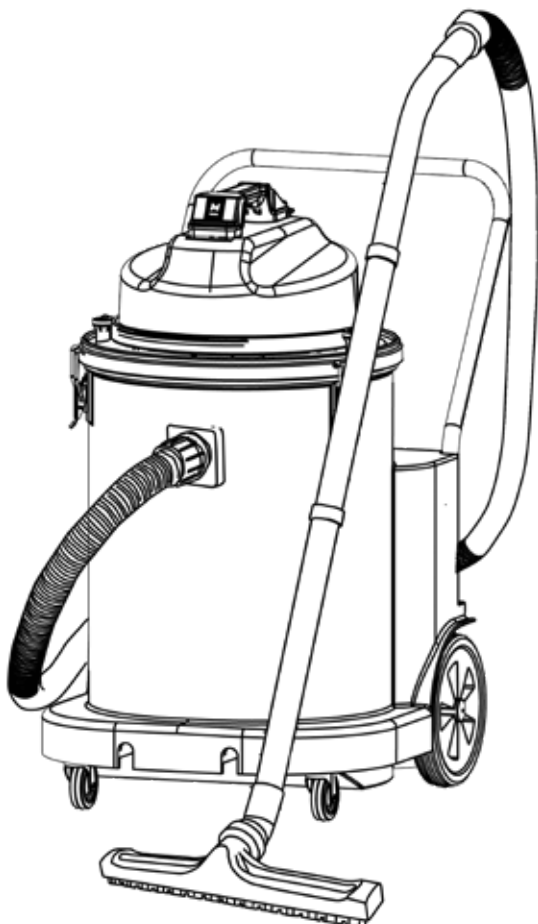
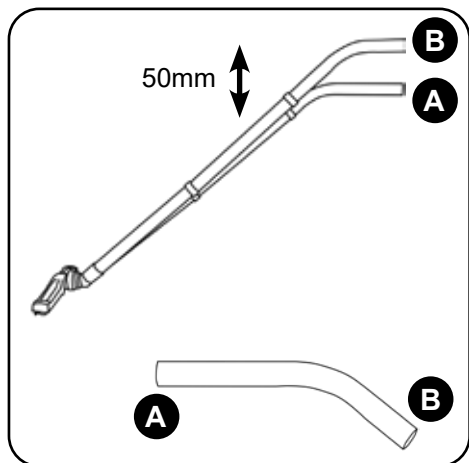
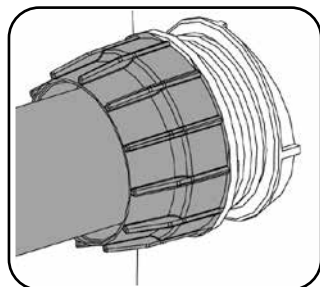
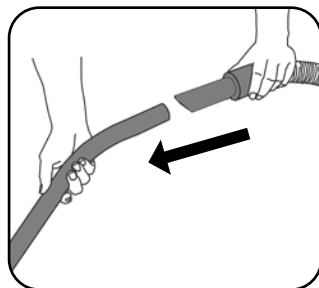
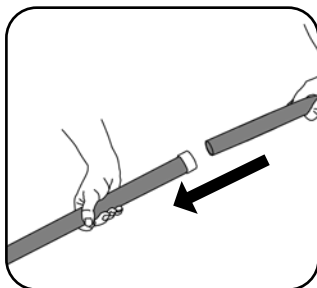
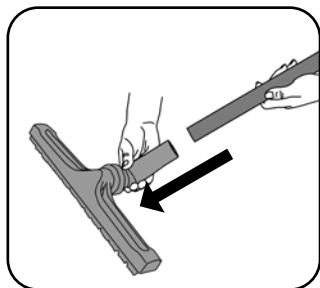
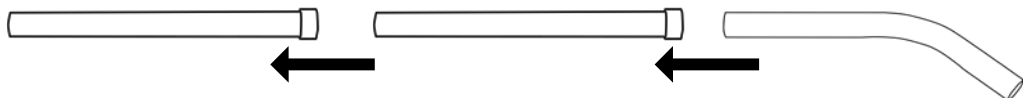

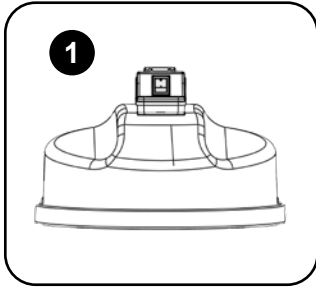

1 Vac

WV 570
WVD570
WV 900
WVD900
WVD1800DH

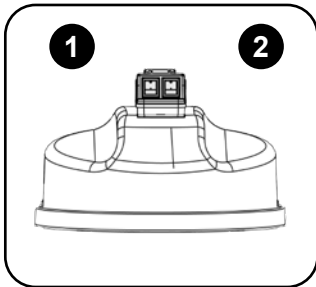

WVD1800PH
WVD1800AP

1 Vac

2 Pump



Cleaning the machine

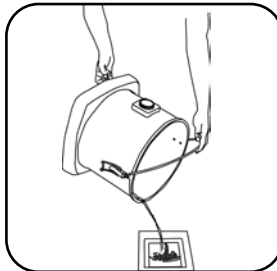
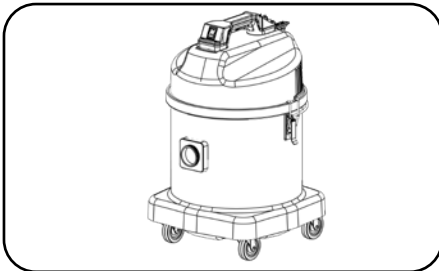

WV 570
WVD 570

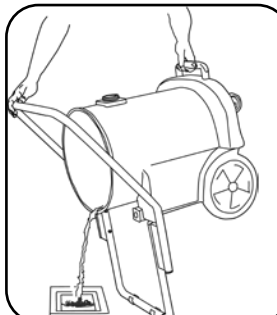

WV 900
WVD 900



WV 750T
WVD 750T

Tipper

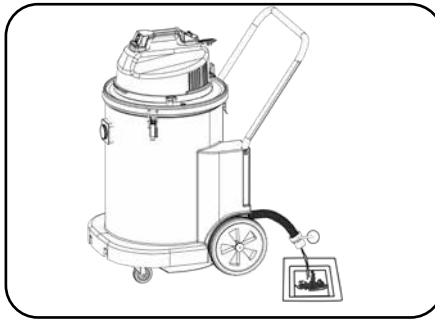

WVD
1800DH

Dump Hose

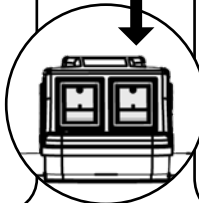

WVD
1800PH / AP

Pump Hose
Auto Pump

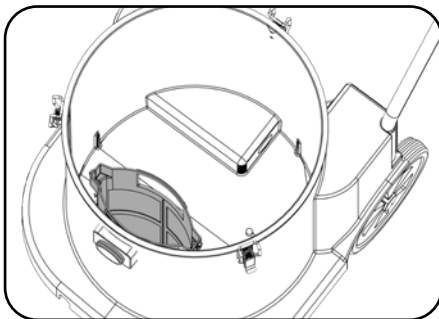

WVD1800DH
WVD1800PH
WVD1800AP

Dry-Assembling the machine



WV 570 / WVD 570
NVM - 3BH

WV 900 / WVD 900
NVM - 4BH

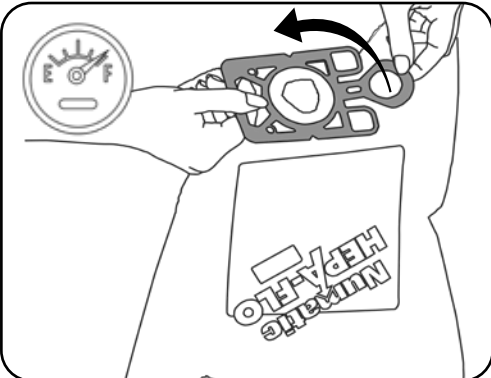
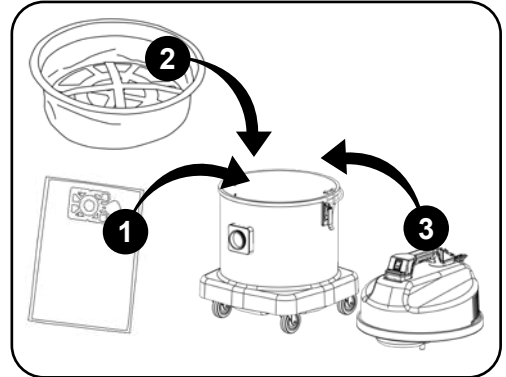
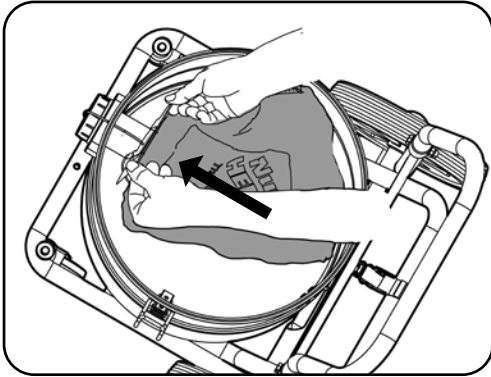
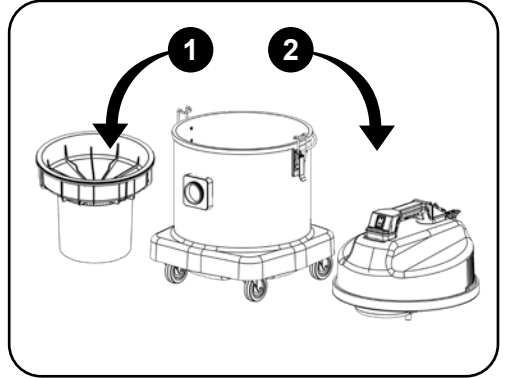
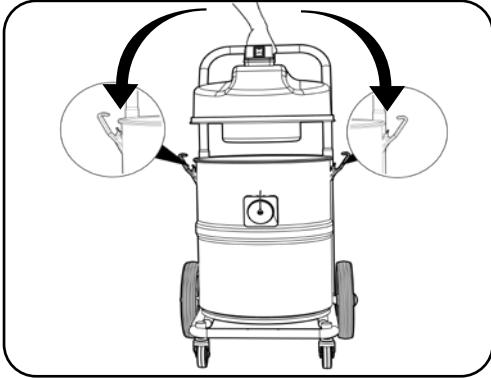

Changing / Replacing Cable

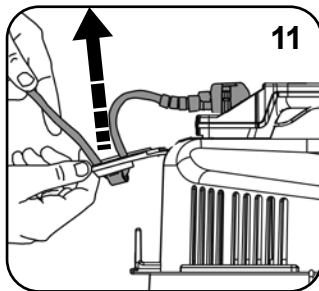
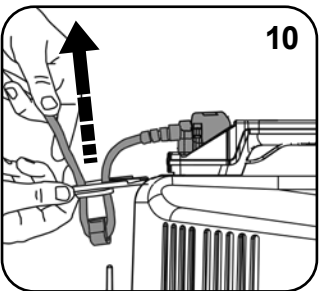
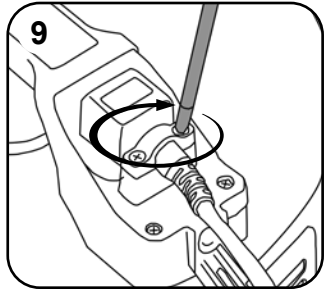
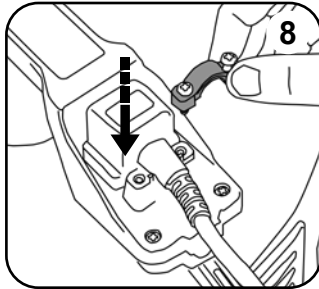
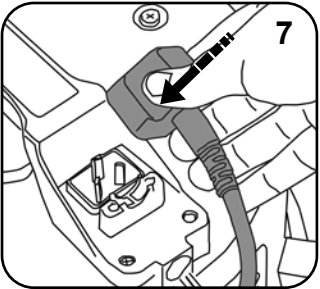
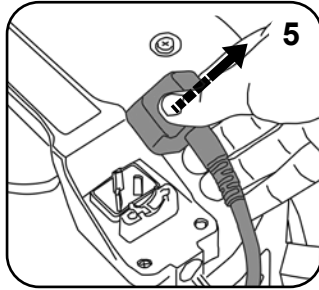
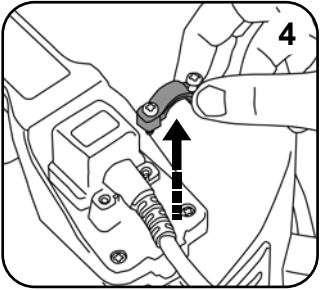
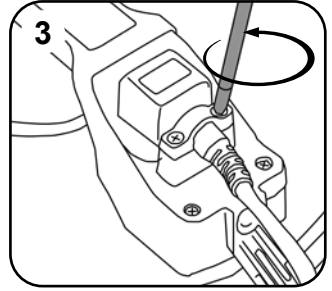
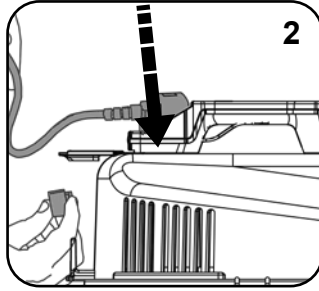
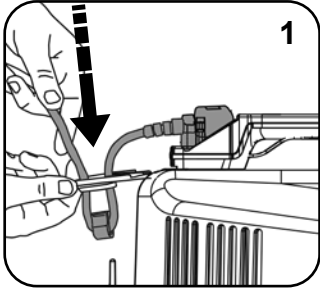

(EN) About your machine

Rating Label

1	Company Name & Address
2	Model
3	Voltage/Alternating Current
4	Frequency
5	Rated Input Power
6	Weight
7	Ingress Protection
8	WEEE Logo
9	Protection Class 2 Symbol
10	Approval Mark
11	Machine yr/wk Serial Number

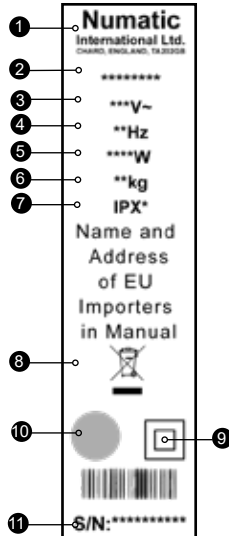

Daily

Keep the machine clean, including hoses and tubes.

Ensure the bag and filter are fitted, (Dry use). Empty dust bag if required.

Clean and check float safety valve for signs of damage.

Regularly examine the power cord. Check filters are clean.

Weekly - as daily and:-

Check for any worn or damaged parts and replace immediately.

MAINTENANCE

WEEE Legislation (Waste, Electrical and Electronic Equipment)

Vacuum cleaner, accessories and packaging should be sorted for environmentally - friendly recycling.

(Only for EU Countries)

Do not dispose of vacuum cleaner into household waste! According to the European Directive 2012/19/EU on waste electrical and electronic equipment and its incorporation into national law.

Vacuum cleaners that are no longer suitable for use must be separately collected and sent for recovery in an environmentally - friendly manner.



PPE (personal protective equipment). That may be required for certain operations.

Ear Protection	Safety Footwear	Head Protection	Safety Gloves	
				Caution Floor Sign
Eye Protection	Protective Clothing	Dust / Allergens Protection	Hi Viz Jacket	

NOTE: A risk assessment should be conducted to determine which PPE should be worn.

Failure to rectify the problem or in the event of a breakdown contact your Numatic dealer or the Numatic Technical helpline +44 (0)1460 269268

Safety Critical Components

Mains leads:

HO5VV-F x 10m x 2 Core x 1.00mm²
 HO5VV-F x 10m x 2 Core x 2.50mm²
 HO5VV-F x 10m x 3 Core x 1.50mm²

Information for WET & DRY use Vacuum Cleaners

Warning

Read the instruction manual before using the machine.

Operators shall be adequately instructed on the use of these machines.

As with all electrical equipment, care and attention must be exercised at all times during use, in addition to ensuring that routine and preventative maintenance is carried out periodically to ensure safe operation. Failure to carry out maintenance as necessary, including the replacement of parts to the correct standard could render this equipment unsafe and the manufacturer can accept no responsibility in this respect.

The machine shall be disconnected from the mains power by removing the plug from the power supply socket during cleaning or maintenance and when replacing parts or converting the machine to another function.

This machine is not to be used by children or persons with reduced physical, sensory or mental capabilities, or lack of experience or knowledge.

Children being supervised are NOT to play with the machine.

This appliance is intended to be assembled, cleaned and maintained by an adult.

This machine is not a toy.

This machine is not suitable for picking up hazardous or explosive dust. Contact your local distributor if you require a machine capable of performing these tasks.

Caution

If foam/liquid comes out of machine exhaust, switch off immediately.

Allow the accumulated liquid to drain out through the machine exhaust, check the float assembly to ensure correct operation, empty the container if full of liquid, reassemble the machine.

Immediately upon start up there will be a certain amount of liquid issuing from the machine exhaust which will be the residue of liquid still within the power head. This will be quickly discharged after which the machine should function normally.

Liquid ejected from the machine could be hazardous as a result of its temperature, pressure or chemical content.

Ensure that the filtration system fitted to the machine is suitable for the material being collected.

This machine is for indoor use only.

This machine shall be stored indoors only. .

When moving from one place to another, consider the weight of the machine.

Notes

You must ensure that the filtration system fitted to the machine is suitable for the material being collected.

This product complies with the requirements of clause 20 of IEC/EN 60335-2-69 Stability and Mechanical Hazards.

The primary use for this machine is commercial, for example in hotels, schools, hospitals, factories, shops and offices.

If the vacuum cleaner stops working, remove the plug from the power supply before investigating where the fault lies.

The vacuum cleaner should be inspected after use for damage.

The power light will illuminate, when your machine is connected to a suitable power supply (where fitted).

Do

- Use a bag and filter at all times when using 'dry'.
- Keep your machine clean.
- Keep filters clean.
- Regularly clean the water level limiting float safety valve and examine for signs of damage or correct operation.
- Keep hoses and tubes clear.
- Replace any worn or damaged parts immediately.
- Regularly examine the power cord, if damage is found, the power cord must be replaced by a special cord available from Numatic or its service agents.

Don't

- Use steam cleaners or pressure washers to clean the machine or use the machine in the rain.
- Immerse in water for cleaning.
- Allow any inexperienced repairs. Call the experts.
- Use wet if float valve is not functioning or fitted.
- Use to suck up hot ashes, or lighted cigarette ends.
- Run the machine over the power cable during operation as a hazard may occur.
- Pull on the cable to unplug the machine from the power supply.
- Walk over-wet carpets, upholstery or fabrics.
- Walk on clean carpets until fully dry.
- Attempt machine maintenance or cleaning unless the power supply plug has been removed from the supply outlet.
- Under any circumstances place foreign objects including (but not limited to) air fresheners, air freshener capsules or scented beads of any type into the top filter of the machine. Doing so can be dangerous and risk damage to the machine and may invalidate the machine warranty.

Fault Finding

Dry Mode maintenance/fault finding

If the vacuum cleaner stops working switch off and remove the plug from the wall before investigating where the fault lies. If the vacuum cleaner will not pick up any debris from the surface, switch off and remove the plug from the wall, inspect the floor tool, wands and hose for blockages, if no blockages are found, the dust bag may be full if the dust bag is not full the filter may be blocked.

Wet mode

If the vacuum cleaner stops working switch off and remove the plug from the wall before investigating where the fault lies. If the vacuum cleaner has a blockage and will not pick up liquid, switch off and remove the plug from the wall, has the float valve operated, this will shut off the suction and the pitch of the vacuum motor will change.

Remove the power head and empty the liquid out of the container, if the container is empty, check that the floor tool wands and hose are not blocked.

Flush the system with clean water after use.

After use always inspect the machine for damage.

	1	2	3	4	5
WV570 WVD570	23 L	26.4 m	16.3 kg 18.5 kg	73.6-79 dB (IEC 60704-2-1) Uncertainty: 0.2 dB (A)	Class II
WV750 WVD750 WVD750T	35 L	26.4 m	21.4 kg	77.5-76.9 dB (IEC 60704-2-1) Uncertainty: 0.2 dB (A)	Class II
WV900 WVD900	40 L	26.4 m	25.2 kg 28.0 kg	73.6-79 dB (IEC 60704-2-1) Uncertainty: 0.2 dB (A)	Class II
WV 1800DH WVD 1800DH WV 1800PH WVD 1800PH WV 1800AP WVD 1800AP	N/A DRY	26.8 m	31.5 kg 34.0 kg 40.4 kg 40.4 kg 40.4 kg	73-77 dB (IEC 60704-2-1) Uncertainty: 0.2 dB (A)	Class II

1	2	3	4	5
Drum Size	Cleaning Range	Weight (Ready to work)	Sound Pressure	Protection Class

6	7	8	9	10	
WV570 WVD570	415 x 415 x 645mm	15 L	49 L/sec 98 L/sec	1060 W 1060 W x 2	2400 mm w.g.
WV750 WVD750 WVD750T	680 x 550 x 940 mm	25 L	49 L/sec 98 L/sec 98 L/sec	1060 W 1060 W x 2 1060 W x 2	2400 mm w.g.
WV900 WVD900	490 x 800 x 880 mm	32 L	49 L/sec 98 L/sec	1060 W 1060 W x 2	2400 mm w.g.
WV 1800DH WVD 1800DH WV 1800PH WVD 1800PH WV 1800AP WVD 1800AP	684 x 785 x 935 mm	70 L	49 L/sec 98 L/sec 49 L/sec 98 L/sec 49 L/sec 98 L/sec	1060 W 1060 W x 2 1060 W 1060 W x 2 1060 W 1060 W x 2	2400 mm w.g.

6	7	8	9	10
Dimensions	Capacity Wet	AirFlo	Power Rating	Suction

Filters/ Baskets/Floats

604145	WV 1800 SERIES TRASH BASKET
604116	PRIMARY PERMATEX FILTER
502034	WV570 FLOAT ASSEMBLY
500609	18 INCH FLOAT ASSEMBLY

Hose

604245	10M DISCHARGE HOSE FOR AP MACHINES
--------	------------------------------------

AP Type - Pump

389120	110V/60HZ.(1800 DRUM)
389121	230V/50HZ.(1800 DRUM)
389123	220V/60HZ.(1800 DRUM)
389126	110V/50HZ.(1800 DRUM)

14" Simplex 240V/120V
WD-0245

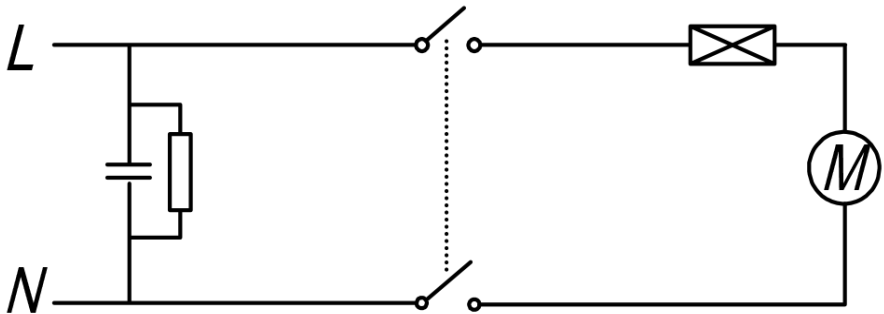

14" (WVD) Duplex 240V
WD-0255

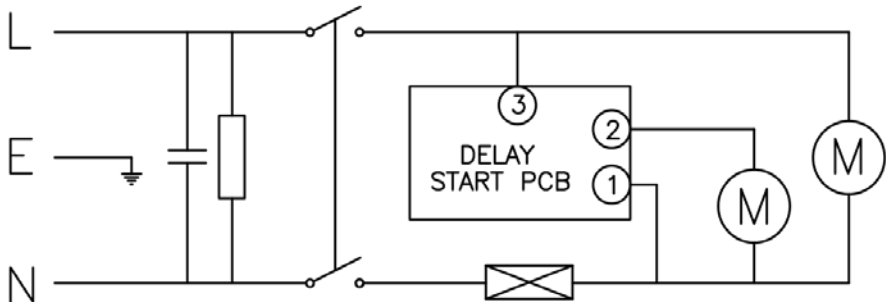

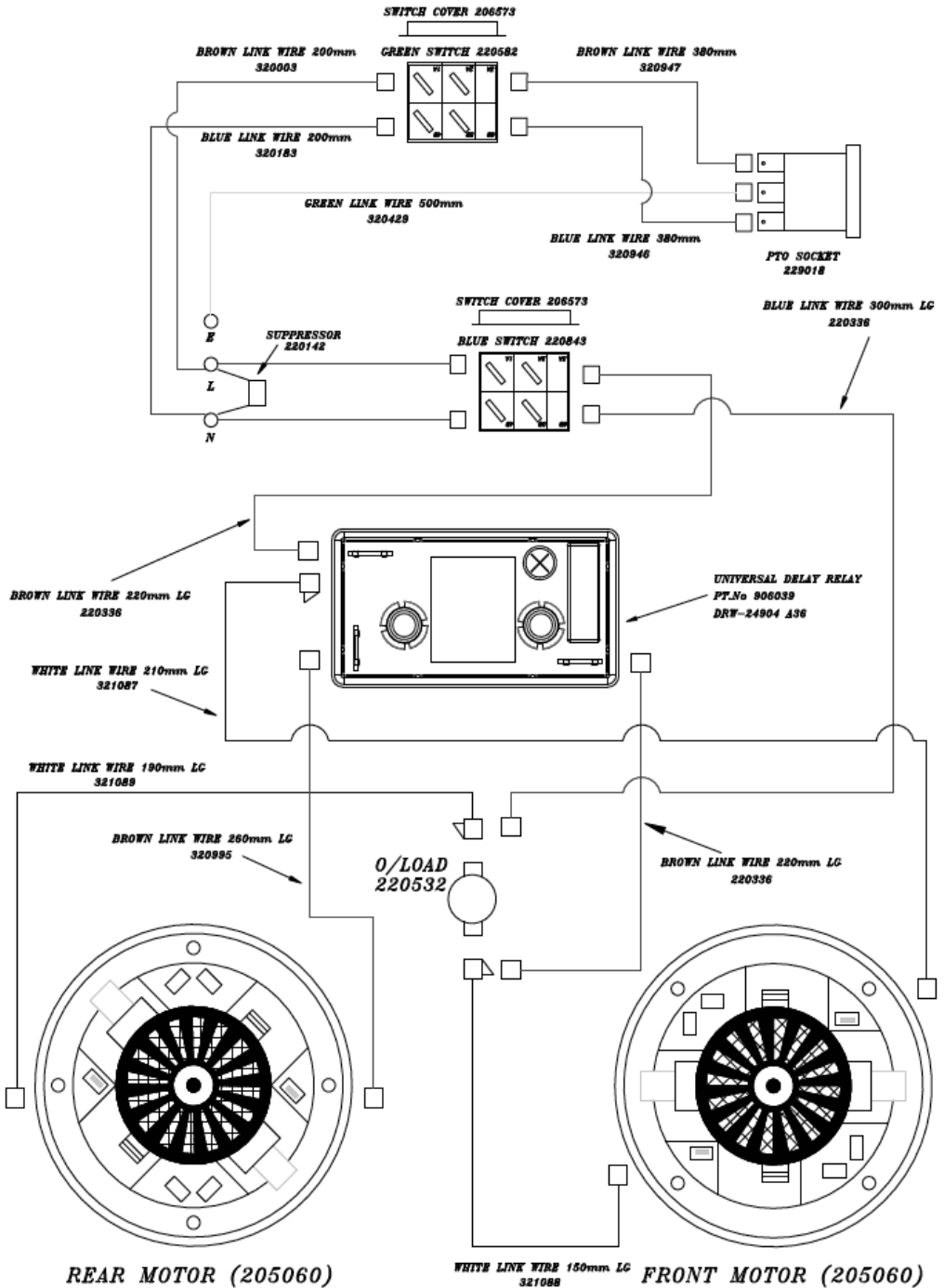

REAR MOTOR (205060)

FRONT MOTOR (205060)

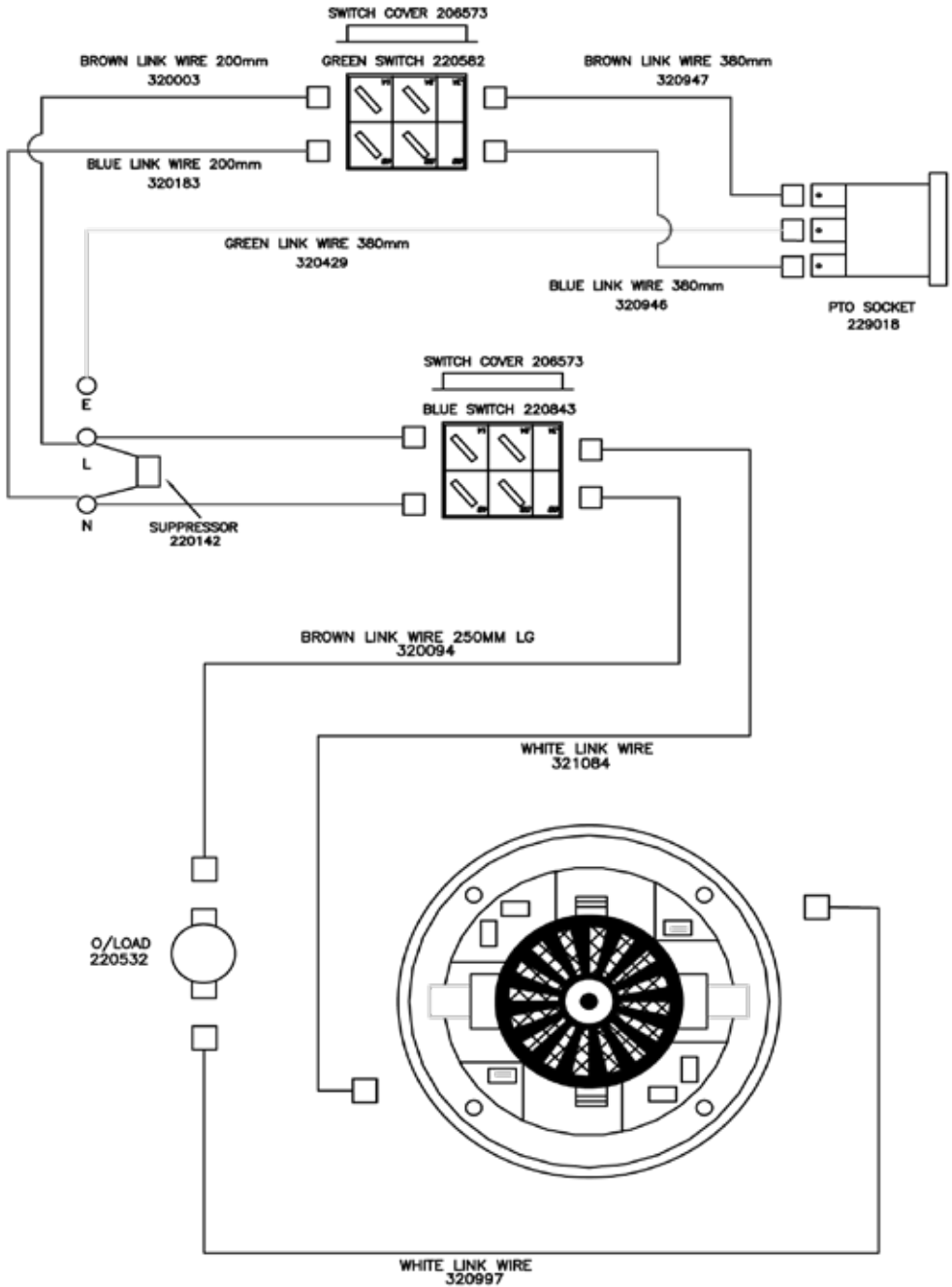

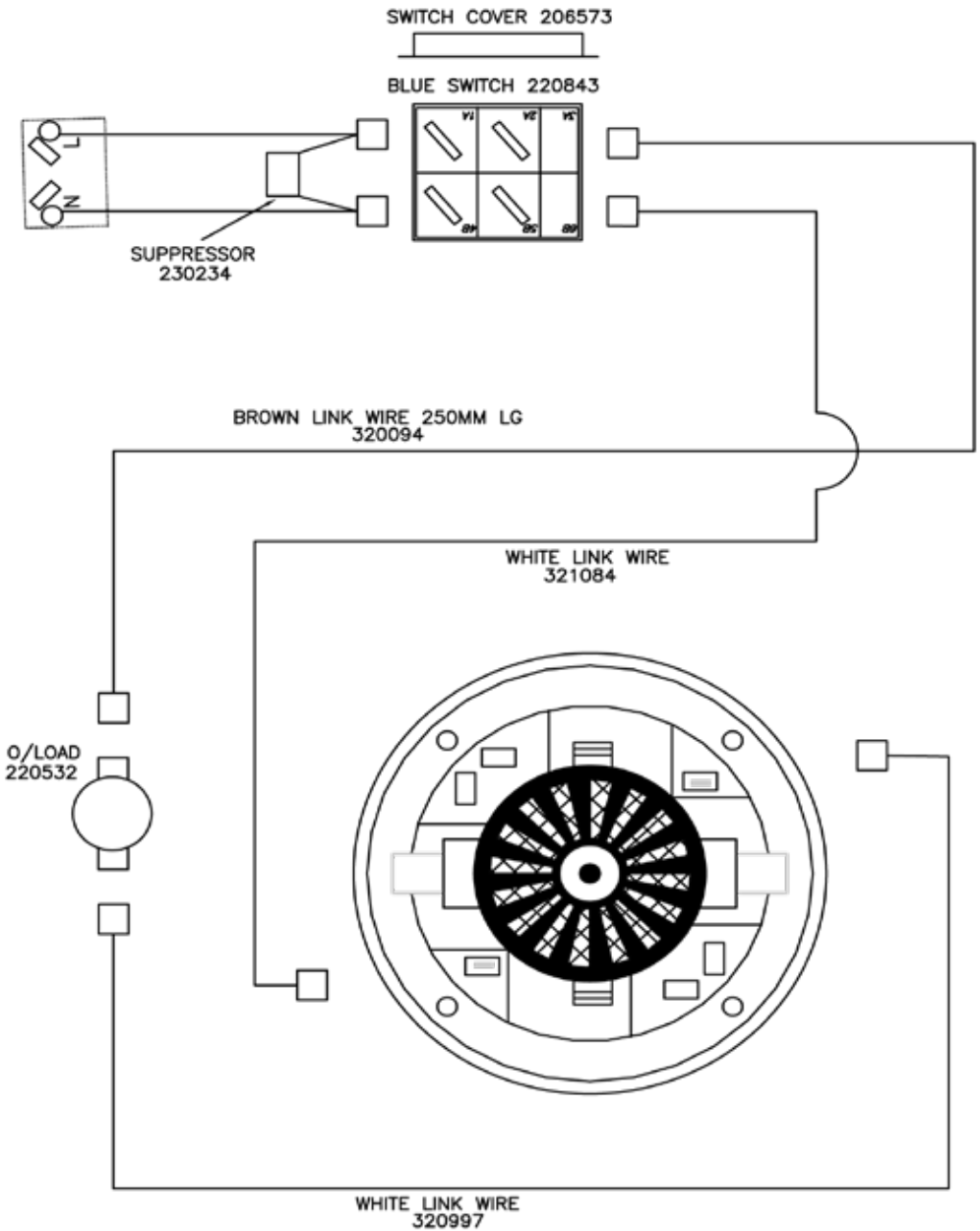

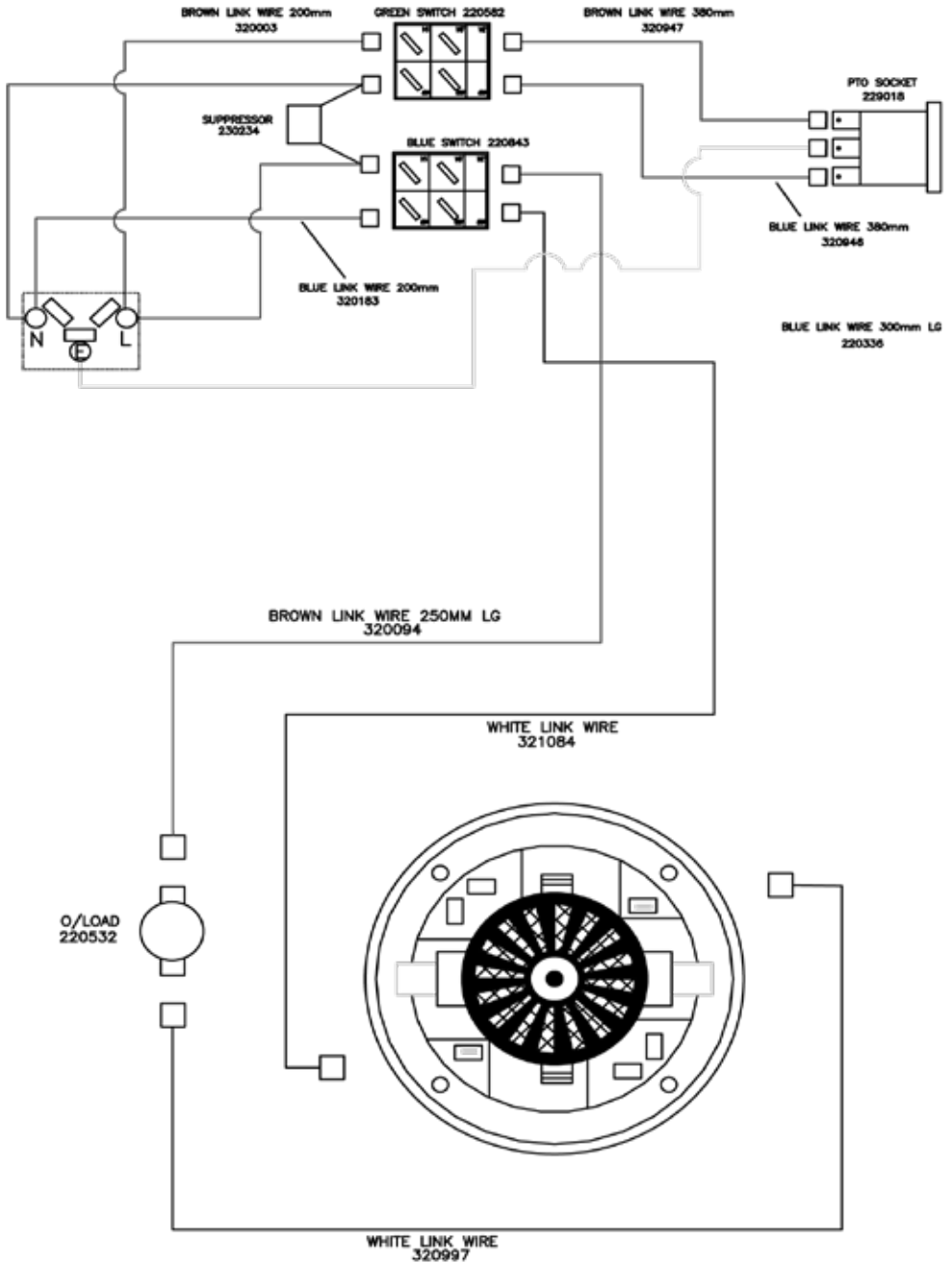

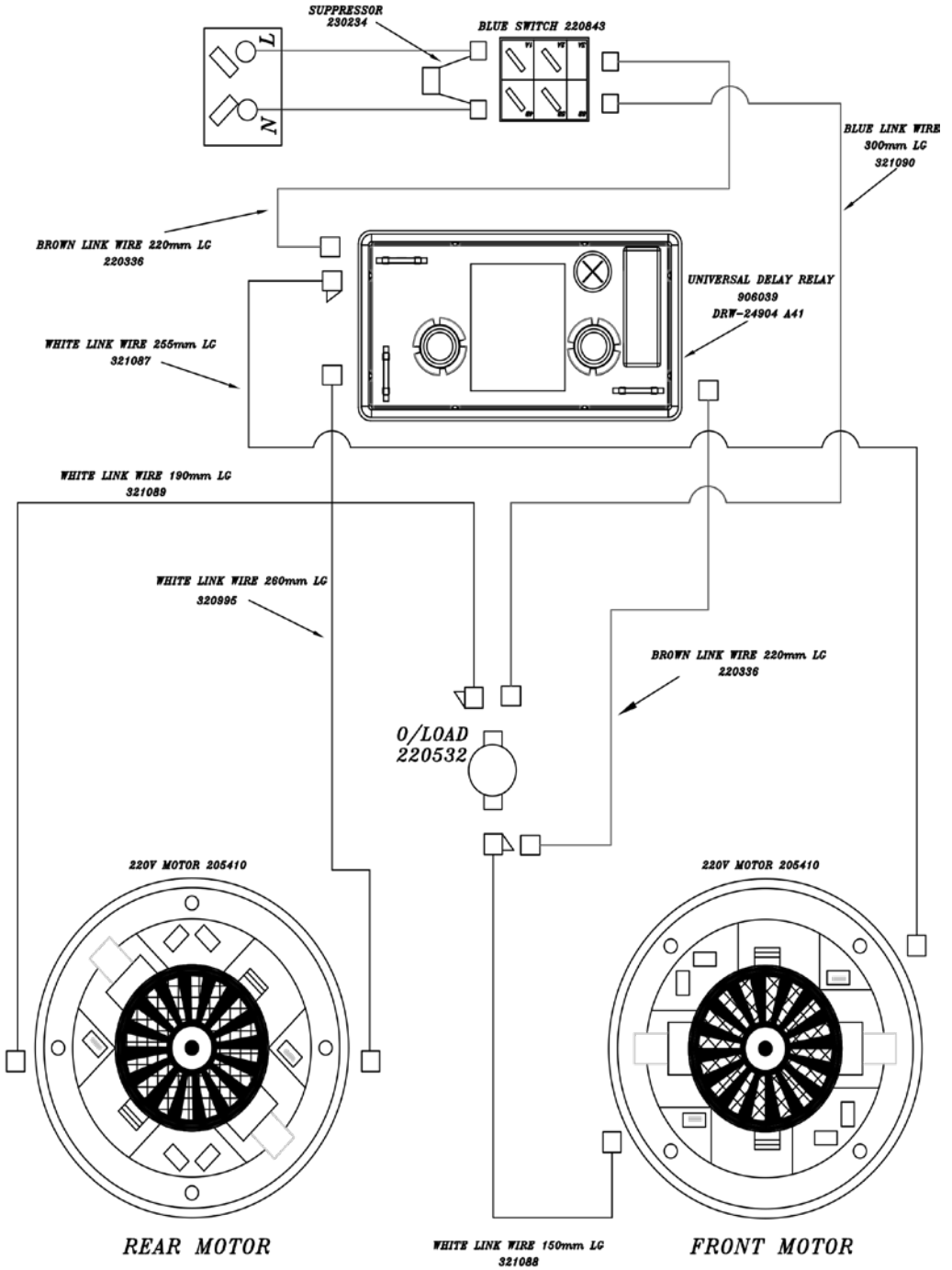

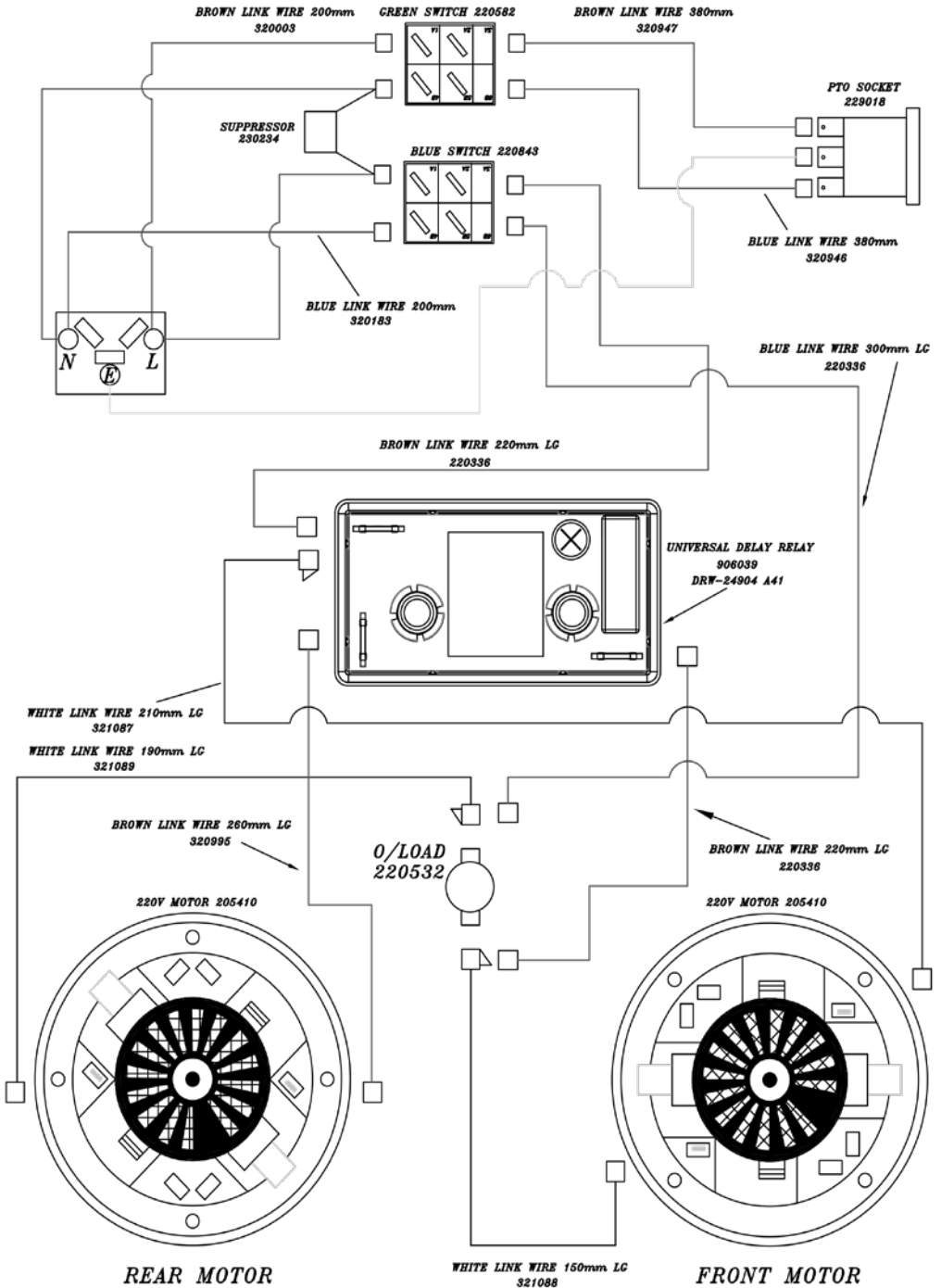

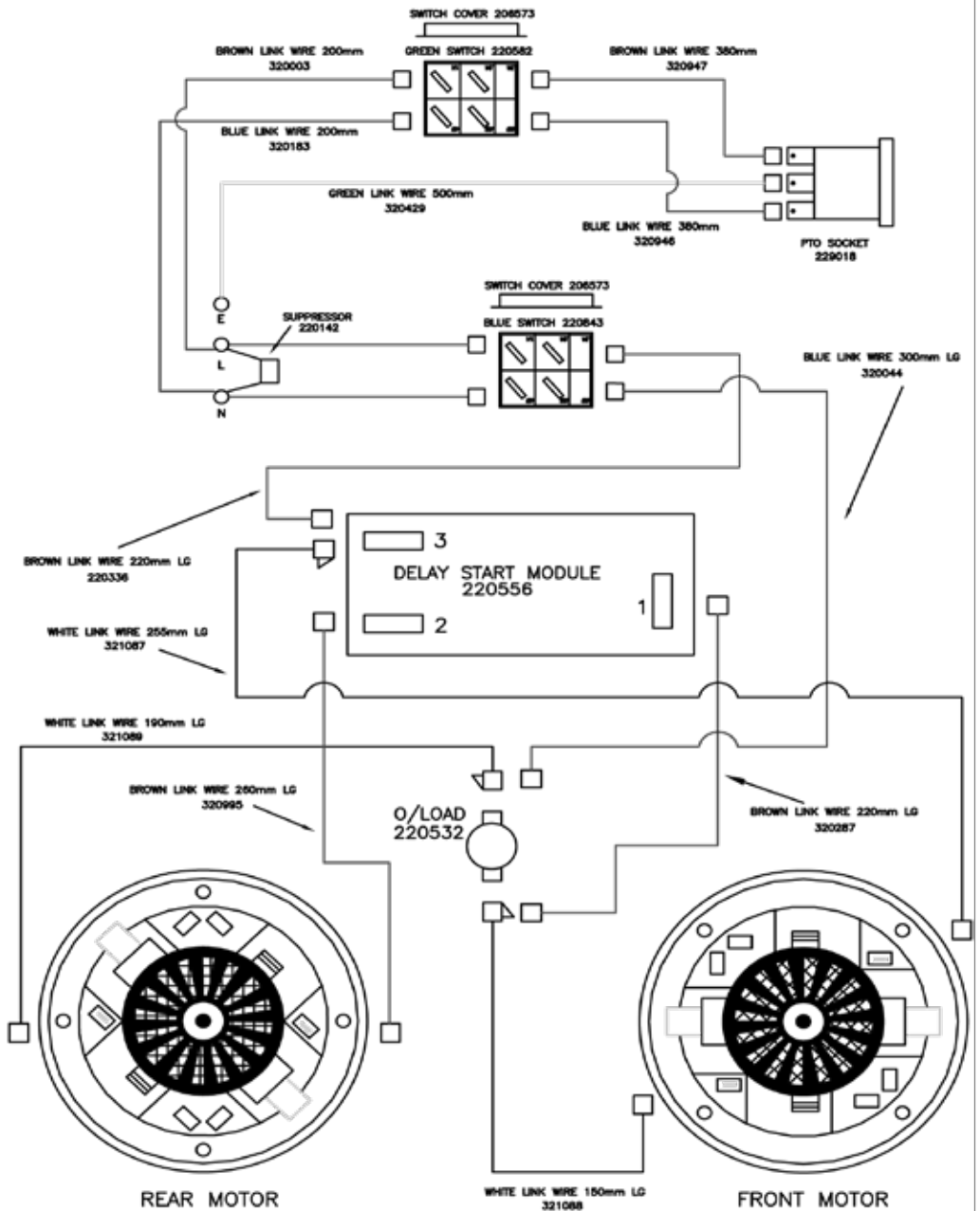

Numatic International Warranty

Numatic International Limited warrant to the original purchaser that its products are free of defects in both material or workmanship for the period shown below:-

Homecare and Cleancare Vacuum cleaners.....	2 Years
Rotary Floor Machines.....	2 Years
Twintec Auto Scrubber Dryer.....	1 Year
Vario Ride-On Scrubber Dryer.....	1 Year / 1500 hours
Mopping, Compacts, Combi and Servocare Products.....	1 Year
Individual Accessories and Spare Parts.....	6 Months

Note: This warranty expressly excludes consumable parts such as carbon brushes, floor brushes, mops, batteries etc, that are considered replaceable from time to time during the normal working life of the machine.

Using non Numatic dustbags can be detrimental to both machine performance and life and may invalidate the Warranty.

A. The warranty period commences from the date the goods are purchased.

B. All warranty claims must be processed through the Dealer from whom the equipment was purchased. The Dealer will co-operate with the purchaser throughout the warranty claims procedure and will arrange any necessary repairs using genuine Numatic parts.

C. If the original Dealer is no longer able to fulfil his obligations please contact Numatic International Limited with full details of the claim and proof of purchase so that this may be processed without delay.

D. Any warranty claim can only relate to the specific part that is proven to be at fault and for which a replacement will be supplied but cannot be extended to constitute a claim against the complete machine.

E. Numatic International will supply the Dealer with any warranty parts required, subject to the claim being validated, after return of the faulty items in accordance with Numatic International Limited's General Conditions of Sale.

F. Claims will not be accepted if they are the result of fair wear and tear, misuse or abuse of any kind.

G. No replacement will be given unless the appropriate evidence of the validity of the claim has been provided to the satisfaction of Numatic International Limited.

H. Numatic International Limited reserve the right to charge for any unnecessary work carried out as a result of an invalid claim.

I. No variation to this warranty may be made or implied by any member of Numatic International Limited or its Dealers unless such variation is in writing and authorised by the Company

Numatic

Numatic International Limited. Chard, Somerset, TA20 2GB

Telephone: 01460 68600 Fax: 01460 68458

© Numatic International Limited



numatic.com

Numatic International Limited (Head Office)

Chard, Somerset TA20 2GB, UNITED KINGDOM
Tel: 01460 68600 numatic.com

Numatic International GmbH

Fränkische Straße 15-19, 30455 Hannover, DEUTSCHLAND
Tel: +49 (0) 511 984 2160 numatic.de

Numatic International Denmark

Fränkische Straße 15-19, 30455 Hannover, DEUTSCHLAND
Tel: +45 (0) 316 40808 numatic-online.dk

Numatic International S.A.S

13/17 rue du Valengelier, EAE la Tuilerie, 77500 Chelles, FRANCE
Tel: +33 (0) 164 726 161 numatic.fr

Numatic International BV

Vennootsweg 15, 2404 CG, Alphen aan den Rijn, NEDERLAND
Tel: +31 (0) 172 467 999 numatic.nl

Numatic International Schweiz AG.

Sihlbruggstrasse 3A, 6340 Baar, SCHWEIZ
Tel: +41 (0) 41 768 0760 numatic.ch

Numatic International (PTY) Ltd.

Cnr. 16th & Pharmaceutical Road, Randjes Park, Midrand 1685, SOUTH AFRICA
Tel: +27 (0) 861 686 284 numatic.co.za

Numatic International ULDA

Rua Francisco da Silva Duarte, n°79,
4475-269 Santa Maria de Avioso, Castêlo da Maia, PORTUGAL
Tel: +351 220 047 700 numatic.pt

NUMATIC INTERNATIONAL SPAIN, S.L.U.

Av. Baix Llobregat, 5-7, Oficina bajos 1 (Parc Negocis Mas Blau II),
08820 El Prat de Llobregat (Barcelona) SPAIN
Tel: +34 93 647 22 22 numatic.es

Numatic International Italy S.R.L

Via Luigi Galvani, 2, Z.I. Talponedo, 33080 Porcia (PN), ITALY
Tel: +39 (0) 434 046 211 numatic.it

Specification subject to change without prior notice
numatic.com © Numatic International Limited