

Owner Instructions
Bedienerhandbuch
Mode d'emploi
Bedieningshandleiding voor de gebruiker



NR 1500 / NRL 1500 NRS 450 NRT 1530 NRU
1500



Original Instructions

CAUTION, Read instructions before using the machine.

Übersetzung der Original-Bedienungsanleitung

VORSICHT, Vor Verwendung der Maschine bitte die Anleitung lesen.

Traduction du manuel d'utilisation d'origine

AVERTISSEMENT, Lisez la notice avant d'utiliser la machine.

Vertaling van de oorspronkelijke gebruiksaanwijzing

LET OP, Lees deze gebruiksaanwijzing voordat u de machine gebruikt.



www.numatic.com

1

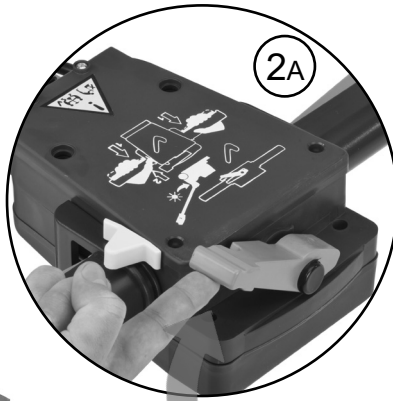
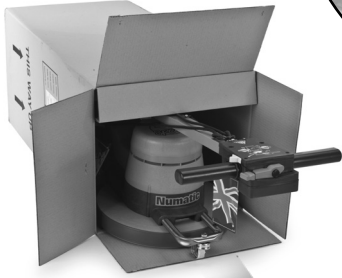

NR 40 / 50Kg
NRT 40 / 50 Kg



2B

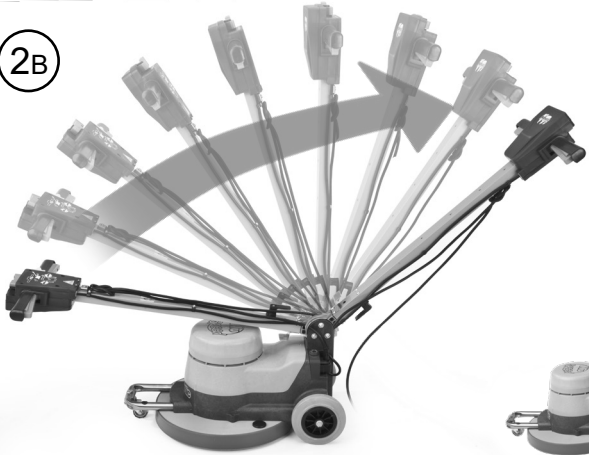

3A



3B

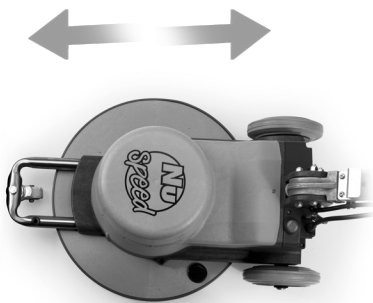

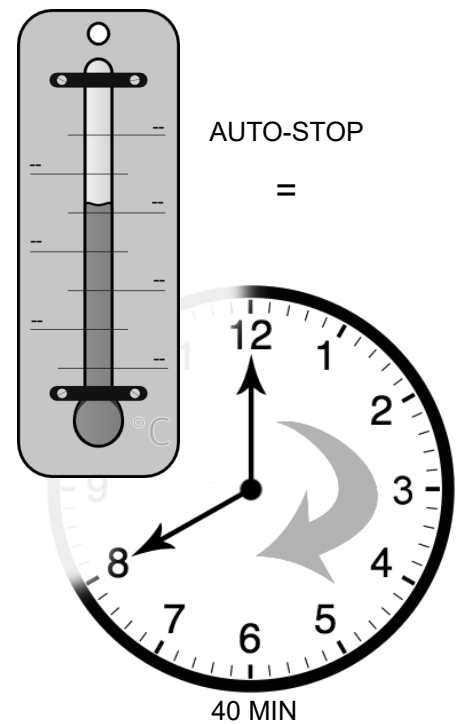
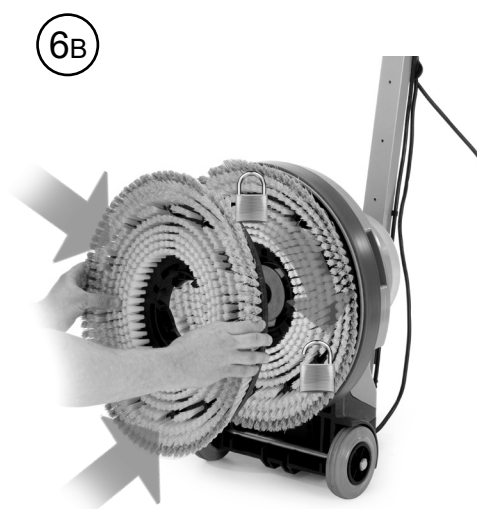
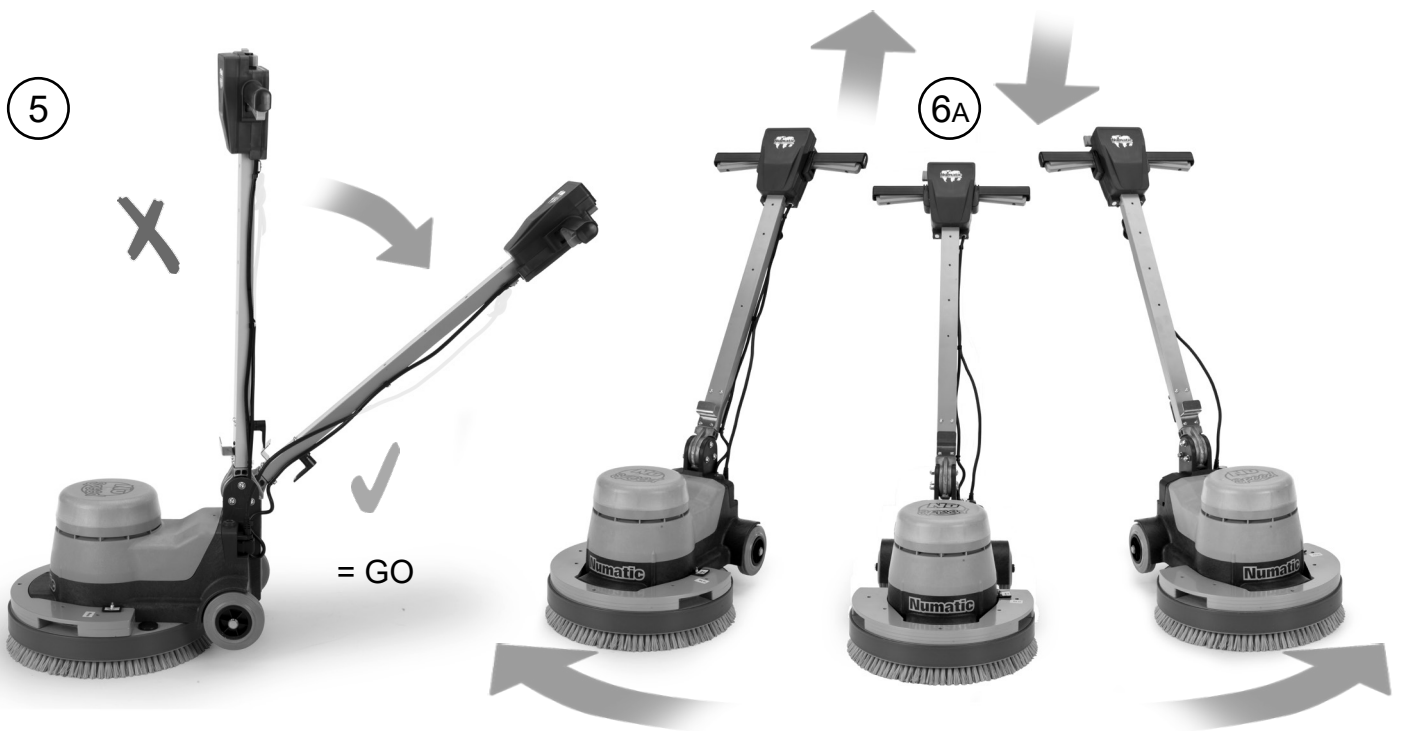
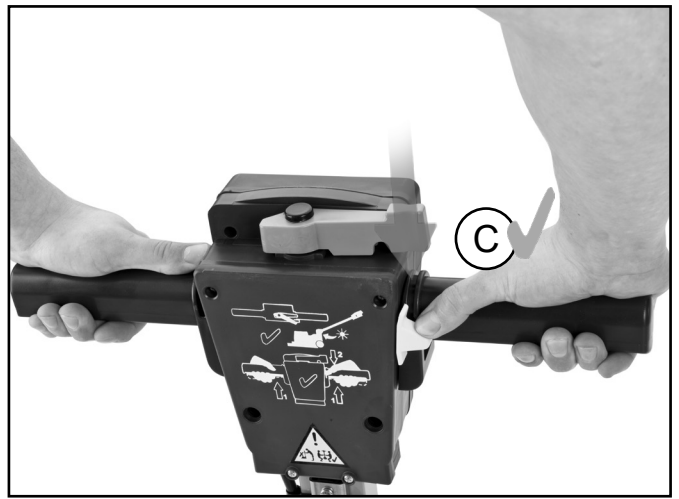
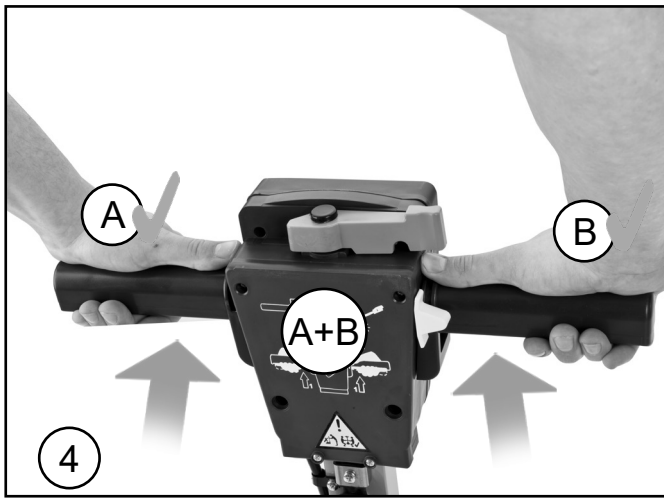

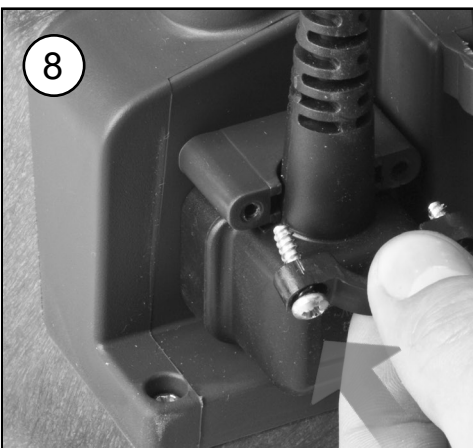
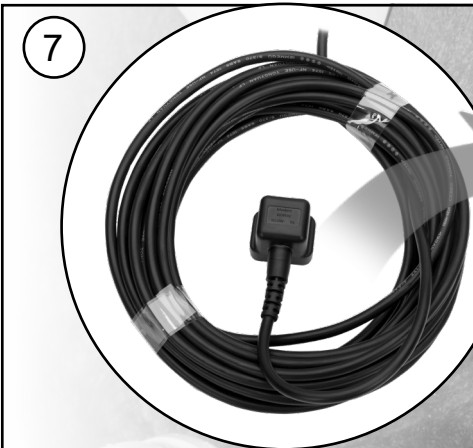
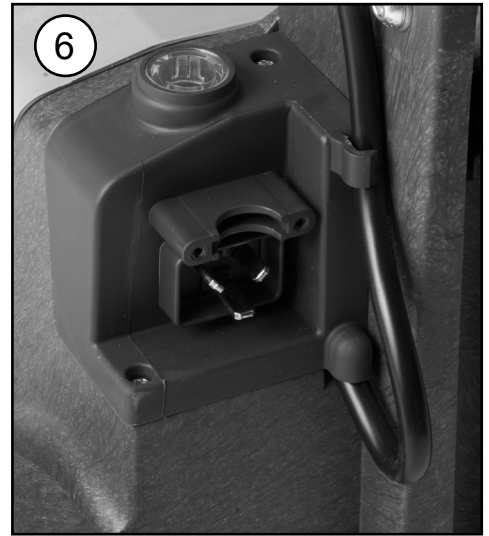
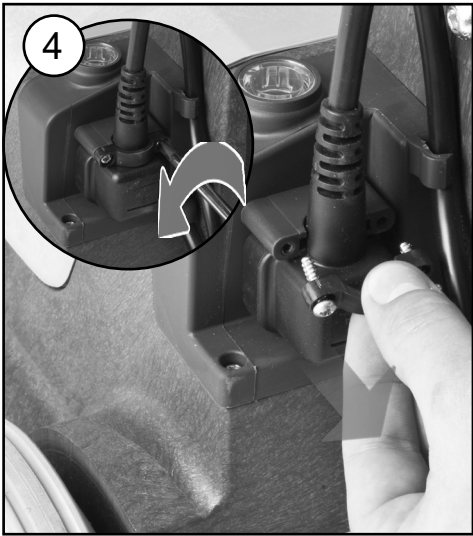
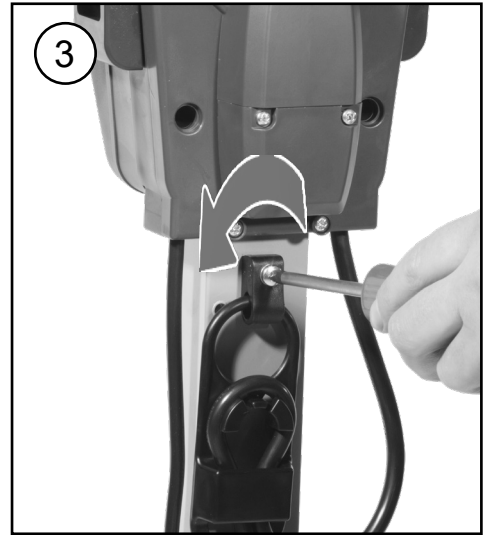
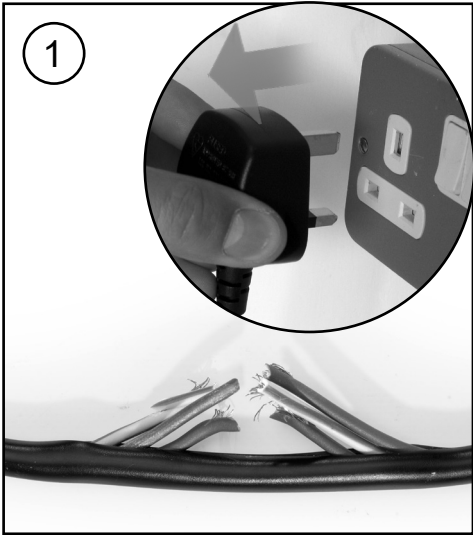

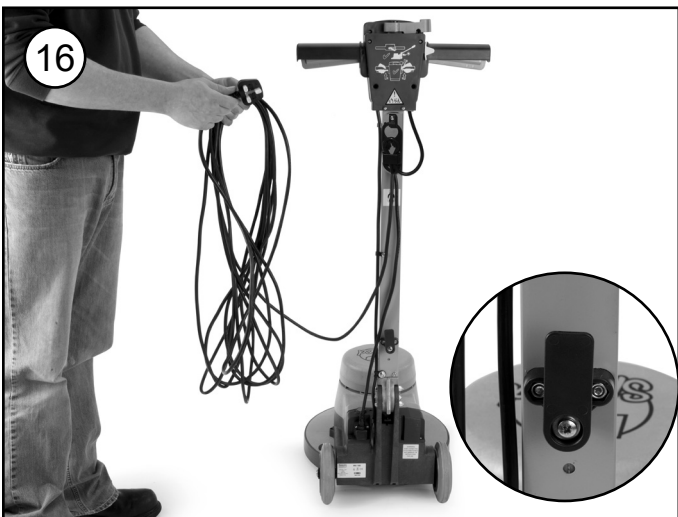
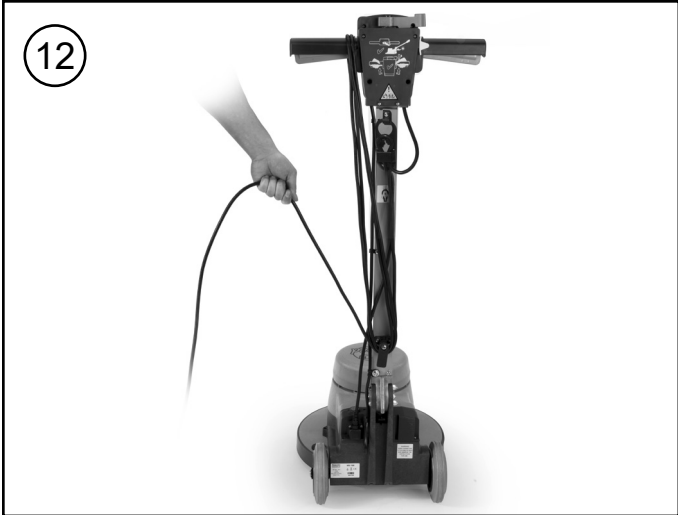
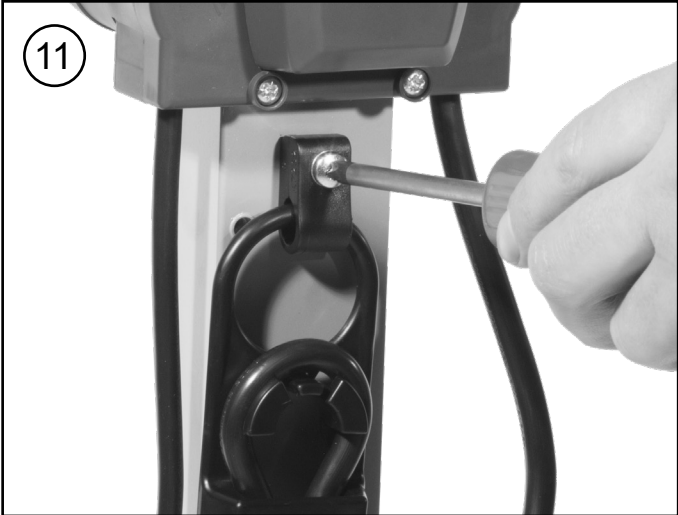



Rating Label

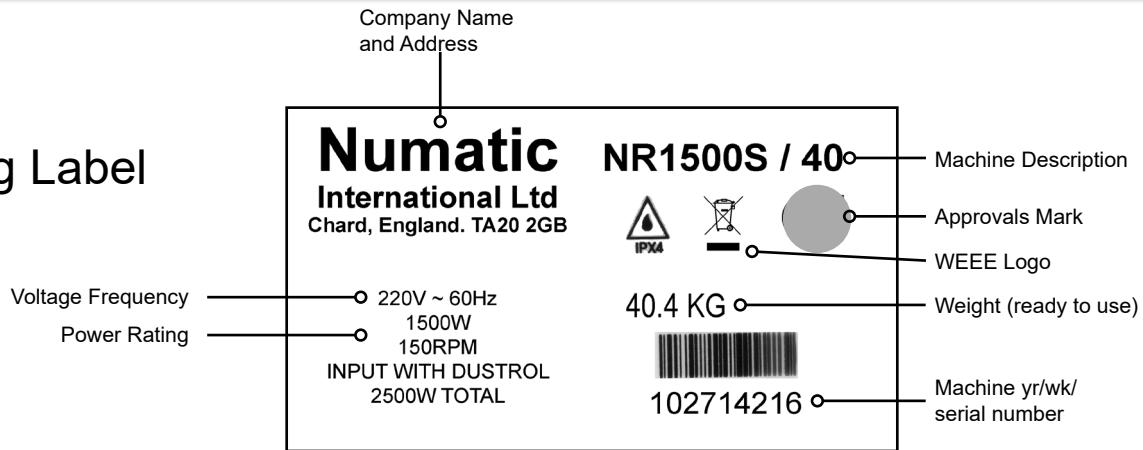

Safety Critical Components

Mains Lead

HO5VV-F 15M x 3 Core x 1.5mm²

Floor Machine, accessories and packaging should be sorted for environmental-friendly recycling



Only for EU countries:

Do not dispose of Floor Machine into household waste!
According to the European Directive 2002/96/EC on Waste Electrical and Electronic Equipment and its incorporation into national law. Floor Machine that are no longer suitable for use must be separately collected and sent for recovery in an environmentally - friendly manner.

PPE
(personal protective equipment)
that may be required for certain operations.



Safety Footwear



Hat Protection



Ear Protection



Safety Gloves



Dust / Allergens Protection



Eye Protection



Protective Clothing



Caution Floorsign

NOTE:

A risk assessment should be conducted to decide what PPE should be worn.



ORIGINAL INSTRUCTIONS READ MANUAL BEFORE USE

CAUTION:

Read the instruction manual before using the appliance

NOTE:

This Product meets the requirements of BS EN 60335 - 2-67

This Machine is also suitable for commercial use, for example in hotels, schools, hospitals, factories, shops and offices for other the normal housekeeping purposes.

Care should be taken in the choice of chemicals, detergents and other liquids. Consult your supplier.

Do's and Don'ts:

- DO Ensure only competent persons unpack/ assemble the machine.
- DO Keep your machine clean.
- DO Keep your brushes in good condition.
- DO Replace any worn or damaged parts immediately.
- DO Daily examine the mains lead for damage, such as cracking or aging. If damage is found, replace the lead before further use.
- DO Only replace the mains lead with the correct Numatic approved replacement part.
- DO Ensure that the work area is clear of obstructions and/ or people.
- DO Ensure that the working area is well illuminated.
- DO Pre - sweep the area to be cleaned.
- DO Remove packing piece NR, NRT 40 / 50 Kg machines.

- DON'T Use steam cleaners or pressure washers to clean the machine or use in the rain.
- DON'T Attempt machine maintenance or cleaning unless the power plug has been removed from the supply outlet.
- DON'T Allow any inexperienced repairs. Contact your nearest service centre.
- DON'T Strain the mains lead or try to unplug by pulling on the mains lead.
- DON'T Leave the brush deck in the lowered position when not in use.
- DON'T Expect the machine to provide trouble free, reliable operation unless maintained correctly.
- DON'T Run the machine over any power cables during operation.
- DON'T Leave your machine standing on brush, pads or drive boards, when not in use.

WARNING:

Operators shall be adequately instructed on the use of this machine.

This machine shall be disconnected from its power source (Remove plug from socket outlet.) During cleaning or maintenance or in the event of an accident and when replacing parts or converting the machine to another function. This machine is not suitable for picking up hazardous dust.

Do not allow supply cord to come into contact with the rotating brushes or pads

As with all electrical equipment care and attention must be exercised at all times during its use, in addition to ensuring that routine and preventive maintenance is carried out

Periodically in order to ensure its safe operation. Failure to carry out maintenance as necessary, including the replacement of parts to the correct standard could render the equipment unsafe and the manufacturer can accept no responsibility or liability in this respect.

When ordering spare parts always quote the model number / serial number specified on the rating plate.

This machine is for indoor use only.

The machine is not to be used or stored outdoors or in wet conditions.

Don't allow the machine to be used by inexperienced or unauthorised operators or without appropriate training.

Only use brushes provided with the appliance or those specified in the instruction manual.

The use of other brushes may impair safety.

A full range of brushes and accessories are available for this product.

Only use brushes or pads which are suitable for the correct operation of the machine for the specific task being performed.

It is essential that this equipment is correct assembled and operated in accordance with current safety regulations. When using the equipment always ensure that all necessary precautions are taken to guarantee the safety of the operator and any other persons who may be affected.

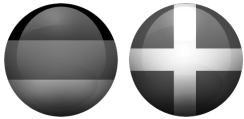

Produktplakette

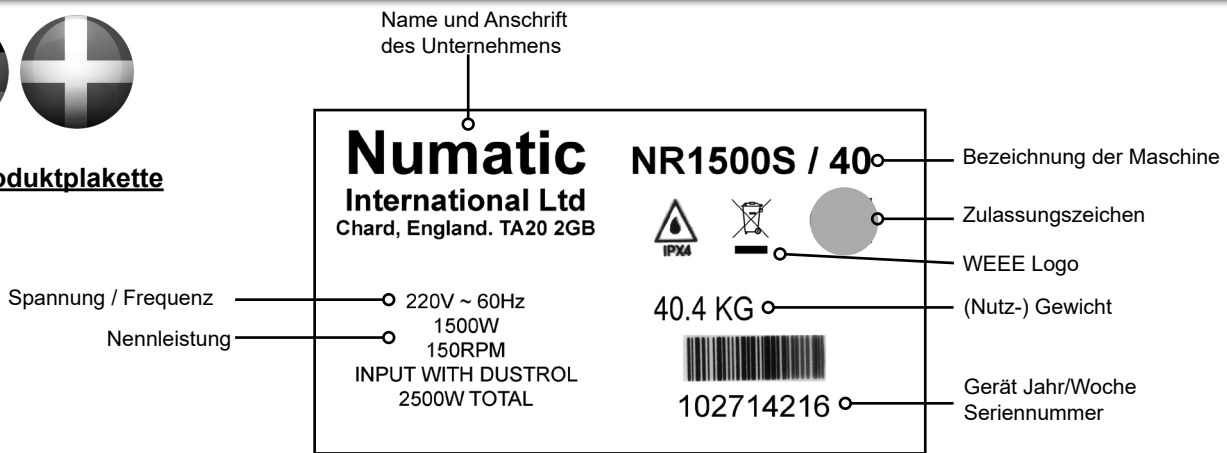

Sicherheitsrelevante Bestandteile

Stromversorgung

HO5VV-F 15M x 3 Core x 1.5mm²

WEEE-Richtlinie

Einscheibenmaschine, Zubehör und Verpackung müssen getrennt entsorgt werden, um ein umweltfreundliches Recycling zu ermöglichen.

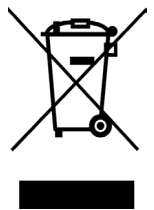

Für EU-Länder gilt:

Entsorgen Sie Einscheibenmaschine nicht im Hausmüll!

- gemäß EU-Richtlinie 2002/96/EC über die Entsorgung von Elektro- und Elektronikgeräten sowie deren Umsetzung in nationales Recht.

Einscheibenmaschine, die nicht mehr verwendet werden können, sind getrennt zu sammeln und zur umweltfreundlichen Entsorgung abzugeben.

In Deutschland sind das i.d.R. Sammelstellen beim örtlichen Entsorger.

PSA

(PERSÖNLICHE SCHUTZAUSRÜSTUNG)

KANN FÜR BESTIMMTE ARBEITEN MIT DEM GERÄT ERFORDERLICH SEIN.



Sicherheitsschuhe



Kopfschutz



Ohrschutz



Sicherheitshandschuhe



Staub-/Allergieschutz



Augenschutz



Schutzkleidung



Hinweisschild „Achtung Rutschgefahr“

Hinweis:

Zur Entscheidung, welche PSA zu tragen ist, sollte eine Risikoabschätzung vor Ort vorgenommen werden.

(Änderungen vorbehalten)

Informationen für Einscheibenmaschine

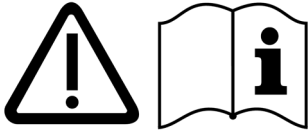

ORIGINALANLEITUNG VOR GEBRAUCH AUFMERKSAM UND VOLLSTÄNDIG LESEN

VORSICHT:

Lesen Sie das Handbuch gründlich durch, bevor Sie das Gerät einsetzen.

ANMERKUNG:

Dieses Produkt erfüllt die Anforderungen gemäß BS EN 60335 - 2-67

Dieses Gerät ist zusätzlich zu seiner Verwendbarkeit in privaten Haushalten auch für den gewerblichen Einsatz geeignet, beispielsweise in Hotels, Schulen, Krankenhäusern, Fabriken, Läden und Büros.

Alle Chemikalien, Waschmittel und andere Flüssigkeiten sind mit Sorgfalt auszuwählen. Wenden Sie sich dazu an Ihren Anbieter.

Worauf zu achten ist:

- Stellen Sie sicher, dass nur entsprechend befähigte Personen das Gerät auspacken/zusammenbauen.
- Halten Sie das Gerät sauber.
- Halten Sie die Bürsten in einem guten Zustand.
- Ersetzen Sie abgenutzte oder beschädigte Teile unverzüglich.
- Überprüfen Sie das Netzkabel täglich auf Beschädigungen, wie z. B. Risse oder Alterungserscheinungen. Wenn Sie feststellen, dass das Kabel beschädigt ist, ersetzen Sie es, bevor Sie weiterarbeiten.
- Ersetzen Sie das Netzkabel nur durch das korrekte, von Numatic genehmigte Ersatzteil.
- Stellen Sie sicher, dass sich keine Hindernisse oder Personen im Arbeitsbereich befinden.
- Achten Sie darauf, dass der Arbeitsbereich gut beleuchtet ist.
- Wischen Sie den zu reinigenden Bereich vor.
- Entfernen Sie die Transportsicherung an den NR, NRT 40, 50 kg Maschinen.

- Verwenden Sie KEINE Dampf- oder Druckreiniger zum Reinigen des Geräts, und verwenden Sie das Gerät NICHT im Regen.
- Führen Sie KEINE Wartungs- oder Reinigungsarbeiten am Gerät durch, wenn der Netzstecker noch in der Steckdose steckt.
- Lassen Sie Reparaturarbeiten NICHT von unerfahrenen Personen durchführen. Wenden Sie sich an das nächstgelegene Service-Center.
- Belasten Sie NICHT das Netzkabel, und versuchen Sie NICHT, den Netzstecker am Netzkabel herauszuziehen.
- Lassen Sie das Bürstendeck NICHT in der abgesenkten Position, wenn es nicht gebraucht wird.
- Gehen Sie davon aus, dass das Gerät NUR dann störungsfrei und zuverlässig betrieben werden kann, wenn es ordentlich gewartet wird.
- Fahren Sie mit dem Gerät im Einsatz NICHT über Strom führende Kabel.
- Die Maschine nach Gebrauch nicht auf der Bürste oder dem Pad/Treibteller abstellen.

WARNUNG:

Benutzer müssen ausführlich in den Gebrauch dieses Geräts eingewiesen werden.

Dieses Gerät muss von seiner Stromversorgung getrennt werden (der Netzstecker muss gezogen werden), während das Gerät gereinigt oder gewartet wird, wenn es zu einem Unfall gekommen ist, wenn Teile am Gerät ausgetauscht werden oder wenn das Gerät in einen anderen Verwendungsmodus umgeschaltet wird.

Dieses Gerät ist nicht für die Aufnahme von gefährlichem Staub geeignet.

Rotierende Bürsten oder Pads dürfen nicht mit elektrischen Leitungen in Berührung kommen.

Wie bei allen elektrischen Geräten ist während der Benutzung jederzeit Vorsicht und Aufmerksamkeit geboten. Darüber hinaus muss zur Gewährleistung eines sicheren Betriebs in regelmäßigen Abständen eine laufende und vorbeugende Wartung durchgeführt werden. Wenn Sie die Wartung nicht im nötigen Umfang durchführen, darin eingeschlossen das Verwenden von korrekten Ersatzteilen, kann die Sicherheit des Geräts beeinträchtigt werden, und der Hersteller kann weder die Verantwortung noch eine Haftung in dieser Hinsicht übernehmen.

Nennen Sie bei der Bestellung von Ersatzteilen immer die Modell- oder Seriennummer, die auf dem Leistungsschild angegeben ist.

Dieses Gerät ist nur für den Einsatz im Innenbereich ausgelegt.

Das Gerät darf in Außenbereichen oder unter feuchten Bedingungen weder eingesetzt noch abgestellt werden.

Das Gerät darf nicht von unerfahrenen, nicht berechtigten bzw. nicht entsprechend geschulten Personen bedient werden.

Verwenden Sie nur die Bürsten, die zusammen mit dem Gerät geliefert wurden bzw. die im Handbuch angegeben sind.

Durch die Verwendung anderer Bürsten kann die Sicherheit beeinträchtigt werden.

Für dieses Produkt ist ein umfassender Satz an Bürsten und weiteren Zubehörteilen erhältlich.

Verwenden Sie nur Bürsten oder Pads, die für den korrekten Betrieb des Geräts bei der speziellen durchzuführenden Aufgabe geeignet sind.

Es ist entscheidend, dass dieses Gerät richtig zusammgebaut und entsprechend den aktuell geltenden Sicherheitsvorschriften bedient wird. Stellen Sie bei Verwendung des Geräts stets sicher, dass alle notwendigen Sicherheitsvorkehrungen umgesetzt wurden, um die Sicherheit des Bedieners sowie anderer, möglicherweise betroffener Personen zu gewährleisten.

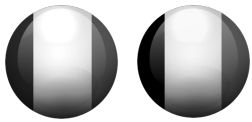

Plaque signalétique

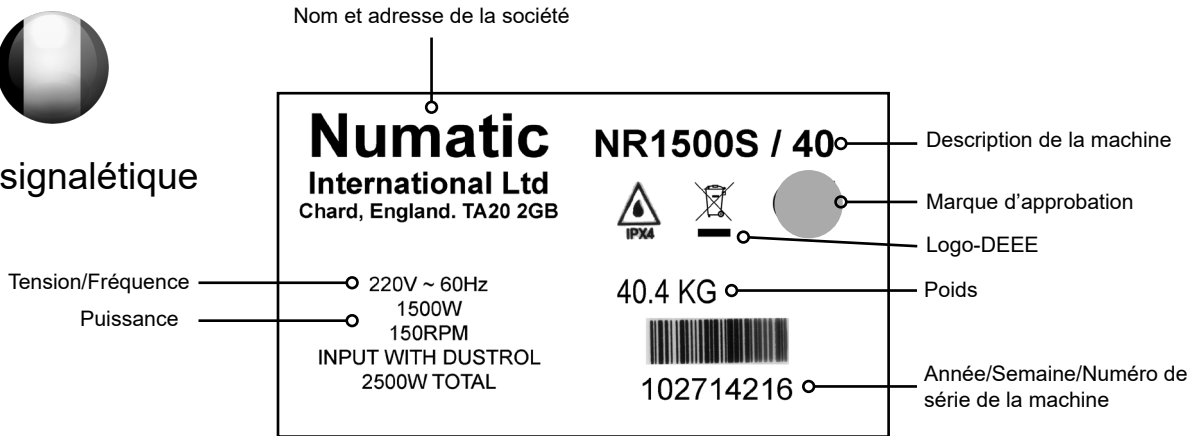

Composants critiques pour la sécurité

Câble d'alimentation

HO5VV-F 15M x 3 core x 1.5mm²

Législation WEEE (DEEE)

Monobrosse, ses accessoires et son emballage doivent être triés pour un recyclage écologique.

Pays de l'UE uniquement :

Ne jetez pas Monobrosse avec les ordures ménagères.

Selon la directive européenne 2002/96/CE relative aux déchets d'équipements électriques et électroniques (DEEE) et à sa transposition au droit national,

Monobrosse qui ne sont plus utilisables doivent faire l'objet d'une collecte sélective et être traités d'une manière respectueuse de l'environnement.



EPI

(Equipement de protection individuelle)

Il peut être nécessaire pour certaines opérations.



Chaussures de sécurité



Casque de protection



Protections sonores



Gants de sécurité



Protection contre la poussière/les allergènes



Protection des yeux



Vêtements de protection



Panneau de signalisation au sol

Note :

Une évaluation des risques devra être menée pour définir les obligations d'utilisation des EPI.
(sujet à modification sans préavis)

Informations concernant Monobrosse



Veillez lire le manuel d'instruction avant d'utiliser l'appareil.
Les utilisateurs doivent être correctement formés à l'utilisation de ces appareils.

MISE EN GARDE :

Lisez le mode d'emploi avant d'utiliser l'appareil.

REMARQUE :

Ce produit est conforme aux exigences de la norme BS EN 60335 - 2-67

Cette machine est également adaptée à un usage commercial, par exemple pour les hôtels, les écoles, les hôpitaux, les usines, les magasins et les bureaux à des fins autres que les besoins ménagers normaux.

Un soin particulier doit être pris dans le choix des produits chimiques, détergents et autres liquides. Consultez votre fournisseur.

Choses à faire et à ne pas faire :

Veillez à ce que seules des personnes compétentes déballent/assemblent la machine.

Maintenez votre machine propre.

Maintenez vos brosses en bon état.

Remplacez immédiatement toute pièce usée ou endommagée.

Examinez régulièrement le câble d'alimentation pour voir s'il comporte des traces d'endommagement telles que des fissures ou un vieillissement. S'il est endommagé, remplacez-le avant toute nouvelle utilisation.

Remplacez le câble d'alimentation uniquement avec la pièce de rechange correcte approuvée par Numatic.

Assurez-vous que la zone de travail n'est pas encombrée et que personne ne passe par là.

Assurez-vous que la zone de travail est bien éclairée.

Balayez au préalable la zone à nettoyer.

Retirer morceau d'emballage NR, NRT 40 / 50 Kg machines.

N'utilisez pas de nettoyeurs à vapeur ou de nettoyeurs haute pression pour nettoyer la machine et évitez toute utilisation sous la pluie.

Ne procédez pas à l'entretien ou au nettoyage de la machine tant que celle-ci est branchée dans la prise de courant.

Ne laissez pas des personnes inexpérimentées effectuer des réparations. Contactez votre centre de service le plus proche.

N'exercez pas de traction excessive sur le câble, et ne débranchez jamais le câble en tirant dessus.

Ne laissez pas le plateau de brosses dans la position abaissée lorsqu'il n'est pas utilisé.

Ne négligez pas l'entretien de la machine si vous souhaitez qu'elle fonctionne de manière fiable et sans problème.

Ne roulez pas avec la machine sur des câbles électriques pendant l'utilisation.

Ne jamais entreposer ou laisser la machine à l'arrêt sur la brosse ou le plateau.

ATTENTION :

Les opérateurs doivent recevoir des instructions appropriées sur l'utilisation de ces machines.

Cette machine doit être débranchée de sa source d'alimentation (retirez la fiche secteur de la prise de courant) pendant le nettoyage ou l'entretien, ou en cas d'accident, ou pendant le remplacement de pièces ou la conversion de la machine pour changer de fonction.

Cette machine n'est pas conçue pour le ramassage de poussières dangereuses.

Ne laissez pas de fil électrique entrer en contact avec les brosses ou disques

Comme pour tout équipement électrique, il convient d'être prudent et vigilant à tout instant lorsqu'on l'utilise, en plus de s'assurer que son entretien courant et préventif est bien effectué régulièrement pour qu'il reste en bon état de fonctionnement. Si l'entretien nécessaire n'est pas effectué et si l'on ne remplace pas les pièces à changer par des pièces à la bonne norme, l'équipement pourrait devenir dangereux et le fabricant ne pourra accepter aucune responsabilité à cet égard.

Lorsque vous commandez des pièces de rechange, indiquez toujours le numéro du modèle / numéro de série indiqué sur la plaque signalétique.

Cette machine est réservée à un usage intérieur.

La machine ne doit pas être utilisée ni rangée à l'extérieur ou dans un environnement humide.

Ne laissez pas des opérateurs inexpérimentés, non autorisés ou sans formation appropriée utiliser la machine.

Utilisez uniquement les brosses fournies avec l'appareil ou celles qui sont spécifiées dans le mode d'emploi.

L'utilisation d'autres brosses peut nuire à la sécurité.

Une gamme complète de brosses et d'accessoires est disponible pour ce produit.

N'utilisez que des brosses ou des disques qui sont appropriés pour le fonctionnement correct de la machine pour la tâche spécifique effectuée.

Il est essentiel que cet équipement soit correctement monté et utilisé conformément aux normes de sécurité actuelles. Lors de l'utilisation de l'équipement, veillez toujours à ce que toutes les précautions nécessaires soient prises pour garantir la sécurité de l'opérateur et de toute autre personne qui pourrait être concernée.



Type Plaatje

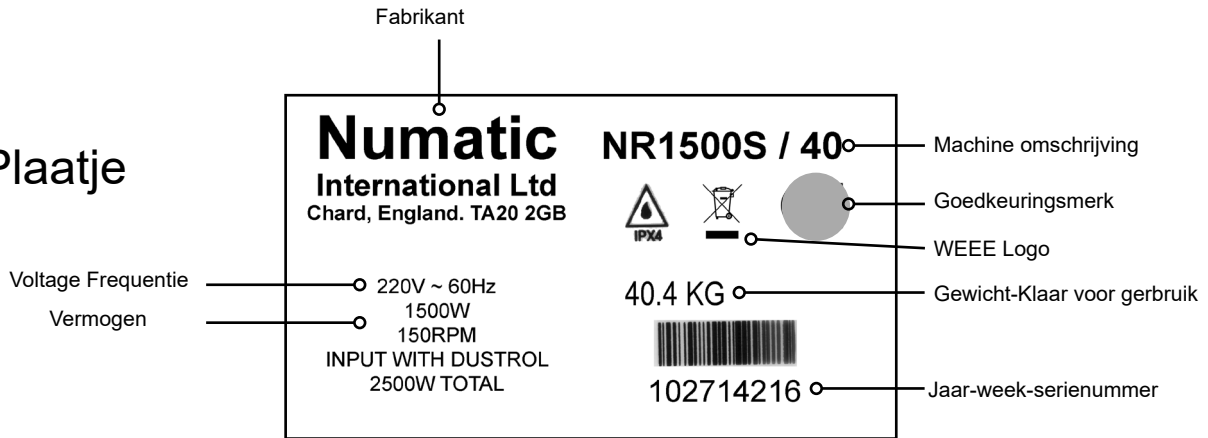

Veiligheidsgevoelige componenten

Aansluitsnoer

HO5VV-F 15M x 3 Core x 1.5mm²

Eenschijf Machine, accessoires en verpakking dienen gesorterd te worden teneinde alle onderdelen milieuvriendelijk te weggooien



Geldt alleen voor EU landen

U mag Eenschijf Machine, volgens de Europese Richtlijn 2002/96/EN met betrekking tot het weggooien van elektronische apparatuur en zoals opgenomen in de Nederlandse wetgeving, niet met het huishoudelijk afval weggooien.

Eenschijf Machine die niet langer geschikt zijn voor gebruik moeten apart worden ingeleverd, zodat ze op een milieuvriendelijke manier kunnen worden verwerkt.

PERSOONLIJKE BESCHERMING

die vereist kan zijn bij het uitvoeren van bepaalde werkzaamheden



Veiligheidsschoeisel



Veiligheidshelm



Gehoorsbescherming



Veiligheidshandschoenen



Adembescherming



Oogbescherming



Beschermende kleding



Waarschuwbord

LET OP:

Een risico-inventarisatie dient te worden uitgevoerd teneinde te bepalen welke bescherming moet worden gebruikt.



Originele gebruiksaanwijzing Lezen voor gebruik

OPGELET:

Lees de gebruikershandleiding alvorens deze machine in gebruik te nemen

OPMERKING:

Dit product voldoet aan de norm BS EN 60335 - 2-67

Deze machine is tevens geschikt voor zwaar gebruik, d.w.z. zwaarder dan huishoudelijk gebruik, zoals bijvoorbeeld in hotels, scholen, ziekenhuizen, fabrieken, winkels en kantoren.

Let erop dat u steeds geschikte chemische producten, schoonmaakmiddelen en andere vloeistoffen gebruikt. Raadpleeg hiervoor uw leverancier.

Wat WEL en wat NIET te doen:

WEL - zorg ervoor dat de machine alleen door ervaren personen worden uitgepakt/gemonteerd.

WEL - houd de machine schoon.

WEL - houd de borstels in goede staat.

WEL - vervang versleten of beschadigde onderdelen meteen.

WEL - controleer de stroomkabel regelmatig op beschadigingen, zoals scheurtjes of slijtage. Vervang het snoer wanneer het is beschadigd, voordat u de machine opnieuw gaat gebruiken.

WEL - Vervang de stroomkabel uitsluitend door het betreffende en door Numatic goedgekeurde vervangende onderdeel.

WEL - zorg ervoor dat er zich geen obstakels en/of mensen in de werkzone bevinden.

WEL - zorg ervoor dat de werkzone goed verlicht is.

WEL - veeg de zone die u gaat schoonmaken vooraf schoon.

WEL - Verwijder het verpakkingsmateriaal stuk NR, NRT 40 / 50 Kg machines

NIET - gebruik geen stoomreiniger of hogedrukspuit om de machine schoon te maken en gebruik de machine nooit in de regen.

NIET - onderhoud of reinig de machine niet terwijl de stekker in het stopcontact steekt.

NIET - laat nooit reparaties door onbevoegden uitvoeren. Neem daarvoor steeds contact op met het dichtstbijzijnde servicecentrum.

NIET - zorg ervoor dat de kabel nooit strak wordt gespannen en haal de kabel nooit uit het stopcontact door eraan te trekken.

NIET - laat de borstelplaat niet omlaag staan wanneer deze niet in gebruik is.

NIET - verwacht niet dat de machine probleemloos zal werken wanneer deze niet correct wordt onderhouden.

NIET - rijd tijdens bedrijf niet met de machine over de stroomkabel.

De machine niet op de borstel, pad of aandrijfschijf laten rusten indien niet in gebruik.

WAARSCHUWING:

Gebruikers dienen goed geïnstrueerd te zijn voordat ze dit soort apparaat bedienen.

Deze machine dient van de stroombron te worden losgekoppeld (haal de stekker uit het stopcontact). Tijdens reiniging, onderhoud of reparatie van de machine, vervangen van onderdelen of het overschakelen naar een andere functie, dient de stroombron uitgeschakeld te zijn.

Deze machine mag niet worden gebruikt voor het opvegen van gevaarlijk stof.

Zorg ervoor dat het snoer niet in contact kan komen met draaiende borstels of pads

Zoals voor alle elektrische apparatuur dient tijdens gebruik steeds de nodige zorgvuldigheid in acht te worden genomen en moet regelmatig periodiek en preventief onderhoud worden uitgevoerd om de veiligheid van de machine te kunnen garanderen. Het niet uitvoeren van het nodige onderhoud of het vervangen van onderdelen door inferieure onderdelen, kan de veiligheid in gevaar brengen. De fabrikant kan hiervoor in geen geval aansprakelijk worden gesteld.

Vermeld bij het bestellen van reserveonderdelen steeds het op het kenplaatje vermelde modelnummer/serienummer.

Deze machine is uitsluitend voor gebruik binnen bestemd.

De machine mag niet buiten of in vochtige omgevingen worden gebruikt of opgeborgen.

De machine mag niet worden gebruikt door onervaren of onbevoegde bedieners die niet de nodige opleiding hebben gekregen.

Gebruik enkel borstels die bij de machine worden geleverd of borstels die uitdrukkelijk in de gebruikershandleiding staan vermeld.

Het gebruik van andere borstels kan de veiligheid in gevaar brengen.

Er is voor deze machine een volledig gamma borstels en accessoires verkrijgbaar.

Gebruik enkel borstels of pads die een goede werking van de machine en een correcte uitvoering van de betreffende taak garanderen. Het is van het grootste belang dat deze machine correct wordt gemonteerd en bediend conform de geldende veiligheidsvoorschriften. Let er bij het gebruiken van deze machine steeds op dat alle nodige voorzorgsmaatregelen worden genomen om de veiligheid van de bediener en mogelijke omstaanders te garanderen.

Floor Machines Application Chart (NU-Speed Range)

		Scarifying 4, 5, 6	Stripping 7,	Shampoo 3,	Spray Cleaning	Wet Scrubbing 2, 8, 9	Dry Buffing 1, 9	Light Spray Buff 9,	Low Gloss Polish 1,	Medium Gloss Polish 1, 9	High Speed Gloss Polish 9,	Extra High Gloss Polish Burnish
NRT 1530HD	1000W				●	●			●			
	150RPM				●	●			●			
	1250W						●	●		●		
	300RPM						●	●		●		
NR-1500S	1500W	●	●	●	●	●			●			
	150RPM	●	●	●	●	●			●			
NR-1500M	1500W		●	●		●	●		●			
	230RPM		●	●		●	●		●			
NR-1500H	1500W					●	●	●	●			
	300RPM					●	●	●	●			
NRS-450	1500W				●		●	●		●	●	
	450RPM				●		●	●		●	●	
NRU-1500	1500W	Pad Size 400mm Ultra High Speed Pads Only									◆	◆
	1500RPM	Pad Size 400mm Ultra High Speed Pads Only									◆	◆

Numatic Brush Description

- 1) Union Mix Polishing Brush FMA-606102, FMA-606202, FMA-606702 (Bristles Brown).
 - 2) Polypropylene Scrubbing Brush FMA-606105, FMA-606203, FMA-606703 (Outer Bristles Green).
 - 3) Nylon Wet Shampoo Brush FMA-606108, FMA-606204, FMA-606704 (All Bristles White).
 - 4) Scarifying Wire Brush FMA-606114, FMA-606706 Floor Preparation
 - 5) Three Head Silicon Carbide Grinding Discs FMA-606208 Floor Preparation
 - 6) Spirotex FMA-606211 Six Head Heavy Duty Scarifying Brush Floor Preparation
- ### Floortec Padless Brush System (Colour Coded Centre Bristles)
- 7) Black Centre Coded, Heavy Duty Scrubbing And Stripping FMA-606301/FT400-1, FMA-606305/FT450-1, FMA-606315/FT500-1.
 - 8) Green Centre Coded, All Purpose General Scrubbing Brush FMA-606302/FT400-2, FMA-606306/FT450-2, FMA-606316/FT500-2.
 - 9) Red Centre Coded, Light Scrubbing When Wet, General polishing When Dry FMA-606303/FT400-3, FMA-606307/FT450-3, FMA-606317/FT500-3.

NOTE:

10Kg & 20Kg Weight, use only on **standard speed** machines for wet/dry scrubbing, vitrification and crystallisation.

WARNING. FMA-606056 vacuum kits are for dry pick up only **DO NOT** use on wet surfaces.

IMPORTANT

Only use the socket outlet on the appliance for Numatic recommended products .



Model	Motor	Speed	Optional Vacuum	Brush	Pad	Range	Weight	Sound Pressure dB(A)@1.7M	HAV M/S ²	Dimensions
NR-1500S	1500W	150rpm	NTD130	450mm	400mm	32m	40Kg	68.1	1.1	1250x580x460mm
NR-1500M	1500W	230rpm	NTD130	450mm	400mm	32m	40Kg	69.4	0.8	1250x580x460mm
NR-1500H	1500W	300rpm	NTD130	450mm	400mm	32m	40Kg	70.4	1	1250x580x460mm
NRL-1500	1500W	150rpm	NTD130	550mm	500mm	32m	40Kg	70.2	1.1	1250x610x540mm
NRT-1530	1000W/1250W	150/300rpm	NTD130	450mm	400mm	32m	40Kg	69.2	1.92	1250x580x460mm
NRS-450	1500W	450rpm	NTD130	450mm	400mm	32m	35Kg	68.4	1.58	1250x580x460mm
NRU-1500	1500W	1500rpm	NTD130		400mm	32m	35Kg	64.8	1.84	1250x660x460mm

HAV = Hand Arm Vibration

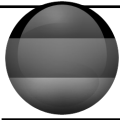

Modell	Motor	Drehzahl	Absaugung (optional)	Bürste	Pad	Arbeitsradius	Gewicht	Schalldruckpegel dB(A)@1.7M	HAV M/S ²	Abmessungen
NR-1500S	1500W	150rpm	NTD130	450mm	400mm	32m	40Kg	68.1	1.1	1250x580x460mm
NR-1500M	1500W	230rpm	NTD130	450mm	400mm	32m	40Kg	69.4	0.8	1250x580x460mm
NR-1500H	1500W	300rpm	NTD130	450mm	400mm	32m	40Kg	70.4	1	1250x580x460mm
NRL-1500	1500W	150rpm	NTD130	550mm	500mm	32m	40Kg	70.2	1.1	1250x610x540mm
NRT-1530	1000W/1250W	150/300rpm	NTD130	450mm	400mm	32m	40Kg	69.2	1.92	1250x580x460mm
NRS-450	1500W	450rpm	NTD130	450mm	400mm	32m	35Kg	68.4	1.58	1250x580x460mm
NRU-1500	1500W	1500rpm	NTD130		400mm	32m	35Kg	64.8	1.84	1250x660x460mm

HAV = Hand-/Armvibration



Model	Moteur	VITESSE	SYSTÈME D'EXTRACTION (EN OPTION)	Brosse	Disque	RAYON DE TRAVAIL	Poids	Niveau de pression sonore dB(A)@1.7M	HAV M/S ²	Dimensions
NR-1500S	1500W	150rpm	NTD130	450mm	400mm	32m	40Kg	68.1	1.1	1250x580x460mm
NR-1500M	1500W	230rpm	NTD130	450mm	400mm	32m	40Kg	69.4	0.8	1250x580x460mm
NR-1500H	1500W	300rpm	NTD130	450mm	400mm	32m	40Kg	70.4	1	1250x580x460mm
NRL-1500	1500W	150rpm	NTD130	550mm	500mm	32m	40Kg	70.2	1.1	1250x610x540mm
NRT-1530	1000W/1250W	150/300rpm	NTD130	450mm	400mm	32m	40Kg	69.2	1.92	1250x580x460mm
NRS-450	1500W	450rpm	NTD130	450mm	400mm	32m	35Kg	68.4	1.58	1250x580x460mm
NRU-1500	1500W	1500rpm	NTD130		400mm	32m	35Kg	64.8	1.84	1250x660x460mm

HAV = Mesure des vibrations main-bras



Model	Motorkop	Toeren	Optionele afzuiging	Borstel	Pad	Bereik	Gwicht	Geluidsdruk dB(A)@1.7M	HAV M/S ²	Afmeting
NR-1500S	1500W	150rpm	NTD130	450mm	400mm	32m	40Kg	68.1	1.1	1250x580x460mm
NR-1500M	1500W	230rpm	NTD130	450mm	400mm	32m	40Kg	69.4	0.8	1250x580x460mm
NR-1500H	1500W	300rpm	NTD130	450mm	400mm	32m	40Kg	70.4	1	1250x580x460mm
NRL-1500	1500W	150rpm	NTD130	550mm	500mm	32m	40Kg	70.2	1.1	1250x610x540mm
NRT-1530	1000W/1250W	150/300rpm	NTD130	450mm	400mm	32m	40Kg	69.2	1.92	1250x580x460mm
NRS-450	1500W	450rpm	NTD130	450mm	400mm	32m	35Kg	68.4	1.58	1250x580x460mm
NRU-1500	1500W	1500rpm	NTD130		400mm	32m	35Kg	64.8	1.84	1250x660x460mm

HAV = Trilling hand / arm

FLOOR MACHINE HAZARDOUS REGULATION INFORMATION.



Under certain uses, this machine may be subject to the Provision and Use of Work Equipment Regulations (council directive 89/655/EEC), Control of Substances Hazardous to Health Regulations, Dangerous Substances and Explosive Atmospheres Regulations and other Safety Regulations (council directive 98/24/EC & 99/92/EC). User must ensure that their use of this machine for any purpose meets these requirements.
Regular inspection and maintenance of this machine in accordance with the manufacturer's recommendations and the above Regulations is essential for its functional and safe operation.



Bei bestimmten Einsätzen unterliegt diese Maschine möglicherweise der Arbeitsmittel-Benutzungsrichtlinie (Richtlinie 89/655/EEC des Rates), der Richtlinie zum Schutz von Gesundheit und Sicherheit der Arbeitnehmer vor der Gefährdung durch chemische Arbeitsstoffe bei der Arbeit, der ATEX-Betreiberrichtlinie für Explosionsschutz und anderen Sicherheitsrichtlinien (Richtlinie 98/24/EG & 99/92/EG des Rates). Der Benutzer muss sicherstellen, dass der Einsatz dieser Maschine für jeden Zweck diese Anforderungen erfüllt.
Für den einwandfreien und sicheren Betrieb dieser Maschine ist ihre regelmäßige Inspektion und Wartung in Übereinstimmung mit den Herstellerhinweisen und den o. g. Richtlinien von grundlegender Bedeutung.



Pour certaines utilisations, cette machine pourra être soumise aux réglementations suivantes :
Directive 89/655/CEE du Conseil concernant les prescriptions minimales de sécurité et de santé pour l'utilisation par les travailleurs au travail d'équipements de travail
"Provision and Use of Work Equipment Regulations".

-Directives 98/24/CE et 99/92/CE du Conseil du Conseil concernant la protection de la santé et de la sécurité des travailleurs contre les risques liés à des agents chimiques sur le lieu de travail et autres réglementations concernant la sécurité
"Control of Substances Hazardous to Health Regulations, Dangerous Substances and Explosive Atmospheres Regulations and other Safety Regulations".

Les utilisateurs doivent s'assurer que leur usage de cette machine pour une application quelconque soit bien conforme à ces exigences.

Afin que cette machine fonctionne correctement et en toute sécurité, il est essentiel qu'elle soit périodiquement contrôlée et entretenue conformément aux recommandations du constructeur et aux Réglementations ci-dessus.



In zekere gebruiksomstandigheden, zijn de Europese Arbeidsmiddelenrichtlijn (Europese richtlijn 89/655/EEC), de richtlijnen voor de beheersing van gevaarlijke stoffen, gevaarlijke stoffen en explosieve omgevingen en andere dergelijke veiligheidsnormen (Europese richtlijnen 98/24/EC & 99/92/EC) van toepassing op deze machine. De gebruiker dient dus zeker te stellen dat de wijze waarop deze machine wordt gebruikt voor welk doel dan ook steeds aan deze veiligheidsnormen voldoet.

Deze machine dient regelmatig te worden gecontroleerd en onderhouden overeenkomstig de aanbevelingen van de fabrikant en de bovenstaande reglementen dienen nauwgezet te worden nageleefd voor een optimale en



1

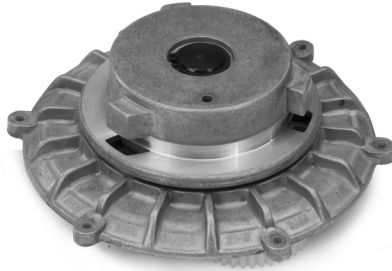

2



3



4



5

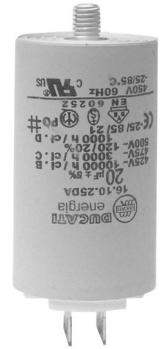

6



7

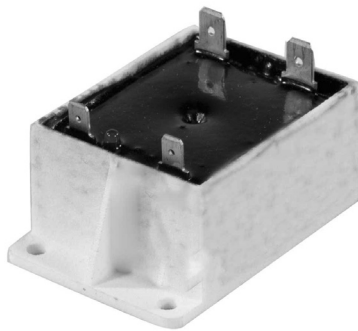

8



9



10



11



12



13



14



15

Spare Parts



		NR1500 S/M/H	NRT 1530	NRU 1500	NRS 450	NRL 1500
1	MOTOR					
	4 pole / 220 - 240v 50Hz	205217	205217			205217
	4 pole / 220 - 240v 50Hz (NO SEAL)			205218		
	4 pole / 220 - 60Hz	205219	205219			205219
	2 pole / 220 - 240v 50Hz				205222	
	2/4 pole / 220 - 240v 50Hz		205223			
2	GEARBOX					
		230206 / S	230206			230206
		230210 / M			230210	
		230209 / H				
3	230V RELAY	206575	206575	206575	206575	206575
4	12v DC FAN	205072	205072	205072	205072	205072
5	START CAPACITOR	208265	208265	208265	208265	208265
6	RUN CAPACITOR	220876	220876	220876	220876	220876
7	VOLTAGE RELAY					
	SINGLE SPEED	206823		206823	206823	206823
	TWO SPEED		206824			
8	UNIVERSAL POWER SUPPLY	206753	206753	206753	206753	206753
9	SOCKET	220964	220964	220964	220964	220964
10	HI LO SWITCH		229465			
11	WHEEL KIT	304267	304267	304268	304267	304267
12	HANDLE SWITCH	229454	229454	229454	229454	229454
13	CABLE					
	UK	236072	236072	236072	236072	236072
	EUROPEAN	236136	236136	236136	236136	236136
	SWISS	236078	236078	236078	236078	236078
	S/A	236081	236081	236081	236081	236081
	AUSTRALIAN	236087	236087	236087	236087	236087
14	HANDLE	577445	577445	577445	577445	577445
15	DECK	606361	606361	329369	606361	606362



Ersatzteile

		NR1500 S/M/H	NRT 1530	NRU 1500	NRS 450	NRL 1500
1	MOTOR					
	4 pole / 220 - 240v 50Hz	205217	205217			205217
	4 pole / 220 - 240v 50Hz OHNE FASE			205218		
	4 pole / 220 - 60Hz	205219	205219			205219
	2 pole / 220 - 240v 50Hz				205222	
	2/4 pole / 220 - 240v 50Hz		205223			
2	GETRIEBE					
		230206 / S	230206			230206
		230210 / M			230210	
		230209 / H				
3	230V RELAIS	206575	206575	206575	206575	206575
4	12V DC LÜFTER	205072	205072	205072	205072	205072
5	ANLAUFKONDENSATOR	208265	208265	208265	208265	208265
6	BETRIEBSKONDENSATOR	220876	220876	220876	220876	220876
7	SPANNUNGSRELAIS					
	1 DREHZAHL	206823		206823	206823	206823
	2 DREHZAHL		206824			
8	UNIVERSELLER NETZAN- SCHLUSS	206753	206753	206753	206753	206753
9	STECKDOSE	220964	220964	220964	220964	220964
10	HI LO SCHALTER		229465			
11	RAD BAUSATZ	304267	304267	304268	304267	304267
12	SCHALTER	229454	229454	229454	229454	229454
13	ZULEITUNG					
	UK	236072	236072	236072	236072	236072
	EUROPÄISCH	236136	236136	236136	236136	236136
	SCHWEIZ	236078	236078	236078	236078	236078
	SÜDAFRIKA	236081	236081	236081	236081	236081
	AUSTRALIEN	236087	236087	236087	236087	236087
14	HANDGRIFF	577445	577445	577445	577445	577445
15	DECK	606361	606361	329369	606361	606362



Pièces Détachées

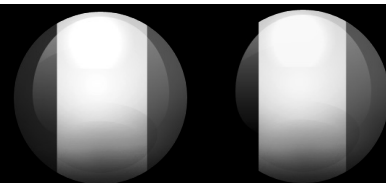

		NR1500 S/M/H	NRT 1530	NRU 1500	NRS 450	NRL 1500
1	MOTEUR					
	4 pole / 220 - 240v 50Hz	205217	205217			205217
	4 pole / 220 - 240v 50Hz SANS JOINT			205218		
	4 pole / 220 - 60Hz	205219	205219			205219
	2 pole / 220 - 240v 50Hz				205222	
	2/4 pole / 220 - 240v 50Hz		205223			
2	RÉDUCTEUR					
		230206 / S	230206			230206
		230210 / M			230210	
		230209 / H				
3	230V RELAIS	206575	206575	206575	206575	206575
4	12v DC VENTILATEUR	205072	205072	205072	205072	205072
5	CONDENSATEUR DE DÉMARRAGE	208265	208265	208265	208265	208265
6	CONDENSATEUR DE MARCHE	220876	220876	220876	220876	220876
7	RELAY DE TENSION					
	1 VITESSE	206823		206823	206823	206823
	2 VITESSE		206824			
8	ALIMENTATION UNIVER- SELLE	206753	206753	206753	206753	206753
9	FICHE	220964	220964	220964	220964	220964
10	HI LO CONTACT		229465			
11	ROUE KIT	304267	304267	304268	304267	304267
12	POIGNÉE CONTACT	229454	229454	229454	229454	229454
13	CÂBLE					
	UK	236072	236072	236072	236072	236072
	EUROPÉEN	236136	236136	236136	236136	236136
	SUISSE	236078	236078	236078	236078	236078
	AFRICAIN DU SUD	236081	236081	236081	236081	236081
	AUSTRALIEN	236087	236087	236087	236087	236087
14	POIGNÉE	577445	577445	577445	577445	577445
15	PONT / PLATEFORME	606361	606361	329369	606361	606362



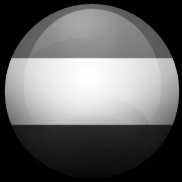

Reserve onderdelen

		NR1500 S/M/H	NRT 1530	NRU 1500	NRS 450	NRL 1500
1	MOTOR					
	4 pole / 220 - 240v 50Hz	205217	205217			205217
	4 pole / 220 - 240v 50Hz GEEN PAKKING			205218		
	4 pole / 220 - 60Hz	205219	205219			205219
	2 pole / 220 - 240v 50Hz				205222	
	2/4 pole / 220 - 240v 50Hz		205223			
2	TANDWIELOVERBRENGING					
		230206 / S	230206			230206
		230210 / M			230210	
		230209 / H				
3	230V RELAIS	206575	206575	206575	206575	206575
4	12v DC Waaier	205072	205072	205072	205072	205072
5	START CONDENSATOR	208265	208265	208265	208265	208265
6	RUN CONDENSATOR	220876	220876	220876	220876	220876
7	RELAIS					
	1 Toeren	206823		206823	206823	206823
	2 Toeren		206824			
8	UNIVERSELESTROOMVOORZIENING	206753	206753	206753	206753	206753
9	STOPCONTACT	220964	220964	220964	220964	220964
10	HI LO SCHAKELAAR		229465			
11	WIEL KIT	304267	304267	304268	304267	304267
12	HANDEL SCHAKELAAR	229454	229454	229454	229454	229454
13	SNOER					
	GB	236072	236072	236072	236072	236072
	EUROPEES	236136	236136	236136	236136	236136
	ZWITSERLAND	236078	236078	236078	236078	236078
	ZUID AFRIKAANS	236081	236081	236081	236081	236081
	AUSTRALISCH	236087	236087	236087	236087	236087
14	HANDEL	577445	577445	577445	577445	577445
15	BORSTELHUIS	606361	606361	329369	606361	606362

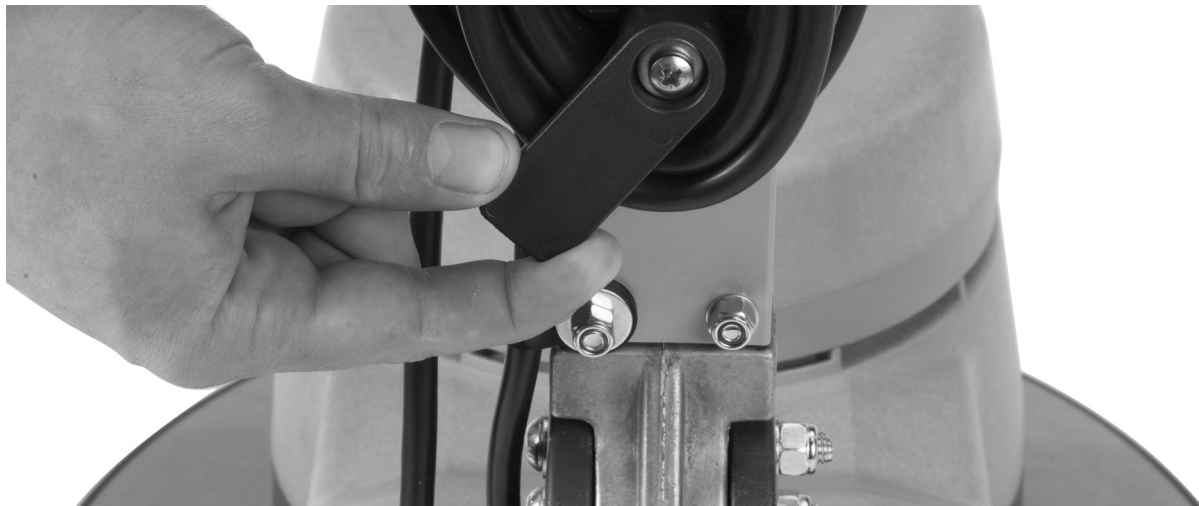

NR / NRU / NRS / NRL 230V (Floor Machine)

WD-0345 (A06) 20.09.11

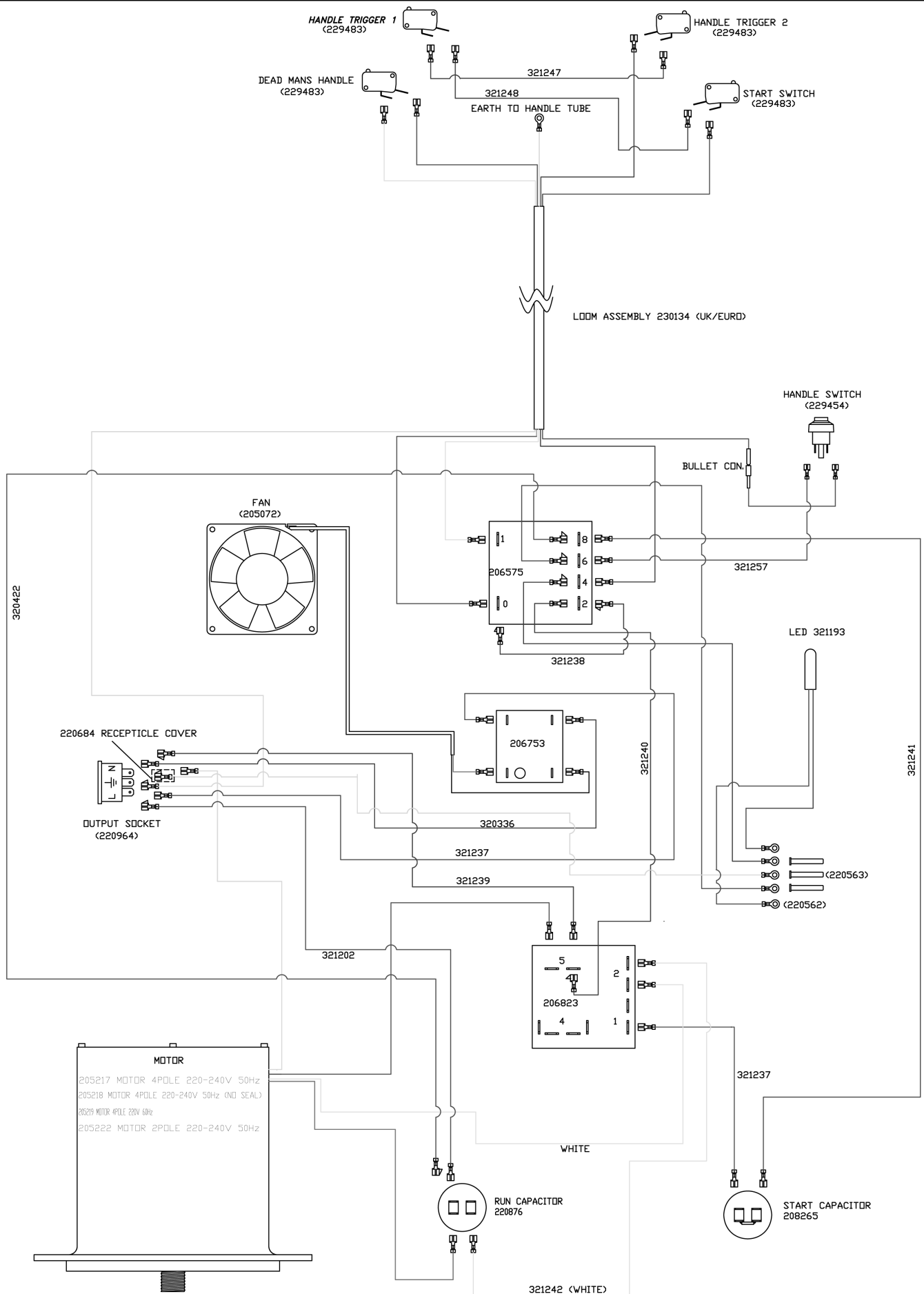

Nuspeed Accessories

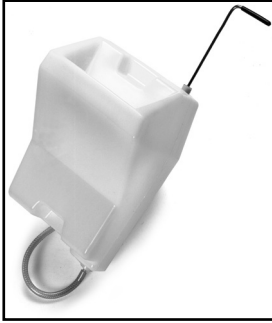

FMA- 606084 NuSpeed Soloution Tank.

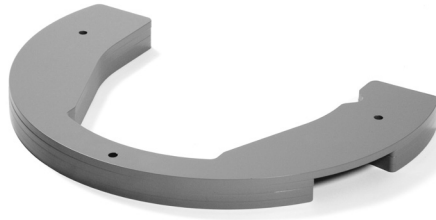

FMA-606113:- NuSpeed extra external 10Kg weight for NR 1500S (40Kg to 50Kg)



FMA-900525:- 400mm Nuloc Pad Drive Board



FMA-606054:- NR optional spraytec Kit



FMA-606202:- 450m Union Mix Polish Brush



FMA-606700:- 400m Porcupine Pad Holder



FMA-606056:- NR Dustrol Kit

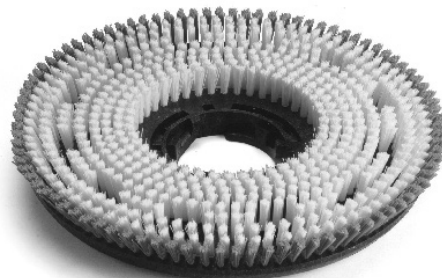

FMA-606203:- 450 Polyscrub Brush

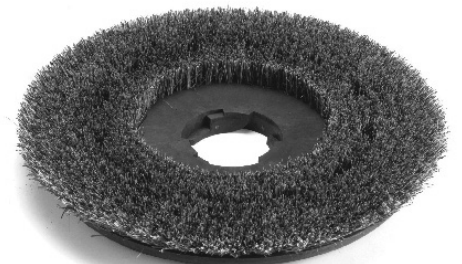

FMA-60115:- 550mm Union mix Polish brush



FMA-606079:- NR/NPR Dustrol Control Brush Ring

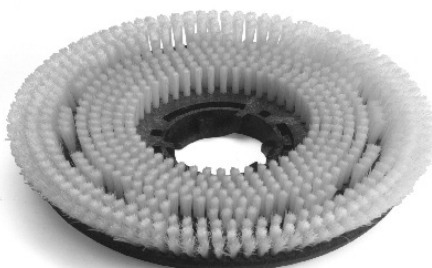

FMA-606204:- 450mm Nyloscrub Brush

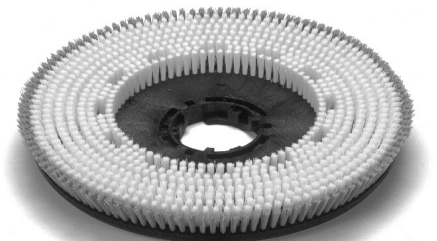

FMA-606028 550mm Polyscrub Brush

- 150rpm - 30Kg / 40Kg / 50Kg

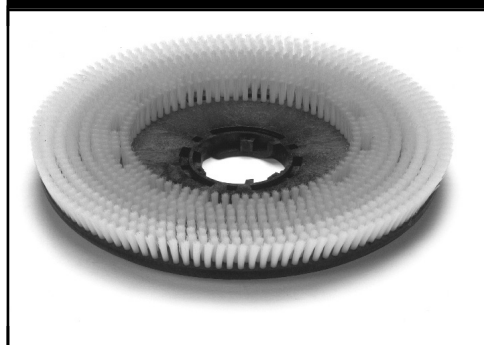

FMA-606550:-550mm Nylloscrub Brush



FMA-606307:- FT 450/3 Floortec Longlife Light Scrubbing Brush.



FMA-606208:- 400mm Carbotex Grinding Disc

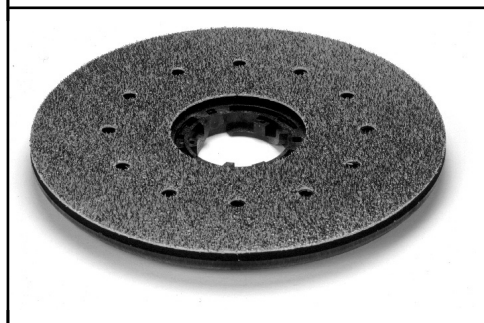

FMA-900526:- 500mm Nuloc Pad Drive Board

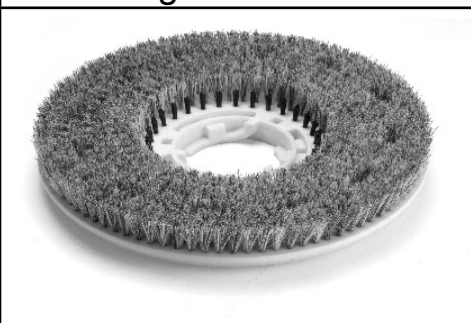

FMA-606308:- 450/4/ Floortec High Lustre Polish Brush

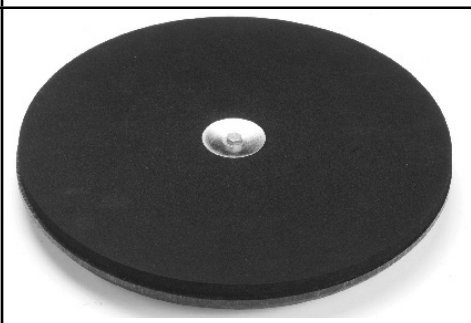

FMA-606209:- 400m Sandotex Disc Drive

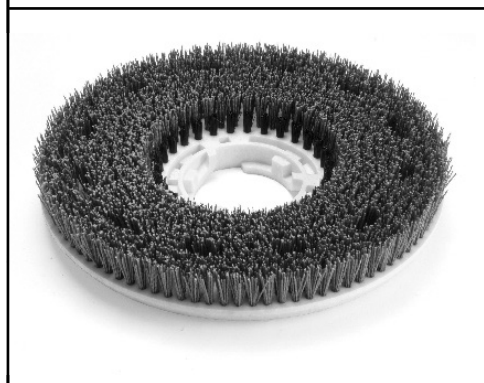

FMA-606305:- FT 450/1 Floortec Heavy Duty Scrubbing/ Stripping Brush



FMA-606551:- 550mm Floortec Longlife Brush



FMA-606211:- 400mm Heavy Duty Scarifying Disc - Spirotex 6 head



FMA-606306:- 450mm floortec Longlife Brush

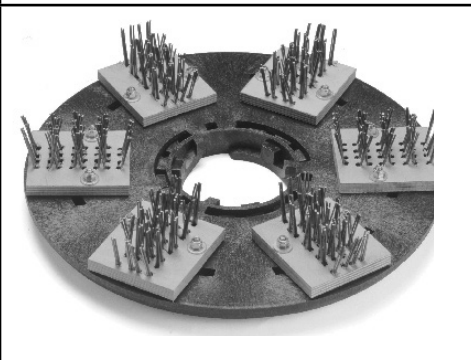

FMA-606207:- 400mm Wire Scarifying Brush



Specialised Accessories - 300rpm



FMA - 900528 Flexi - Pad Drive for use with top quality pads

Specialised Accessories - 450rpm



FMA - 606087
Spider Drive Universal High - Speed
Polishing Brush



FMA - 606078
Spider High - Speed
Pad Drive



FMA - 606086
Spider Drive
High - Speed Short Trim
Burnishing Brush



FMA - 606088
Spider Drive Floortec
High - Speed Long Life
Polishing Brush



UKCA Declaration of Conformity	
Manufacturer:	Numatic International Limited Chard Somerset TA20 2GB www.numatic.co.uk
Product:	NPR, NR
Description:	Single Disc – Floor Treatment - Commercial
We, Numatic hereby declare under our sole responsibility, that the above-mentioned product(s) is/are in conformity with the following directives and standards.	
S.I. 2008: 1597	Supply of Machinery Regulations EN60335-1:2012 + AC:2014 + A11:2014 + A13:2017 + A15:2021 EN60335-2-67:2012 EN62233:2008
S.I. 2016: 1091	EMC Regulations EN55014-1:2017 + A11:2020 EN55014-2:1997 + A1:2001 + A2:2008 EN61000-3-2:2014 EN61000-3-3:2013
S.I. 2012: 3032	RoHS Regulations

Authorised Signatory: Mr. Matthew Coles

Signed: *M Coles* Date: 30th Aug 2023

Position: Head of Technology

Numatic International Limited,
Chard,
Somerset, TA20 2GB, UK

DEC-057 V2.1

EU, EC, EL, UE, ES: Declaration of Conformity Prohlášení o shodě Konformitátserklärung Ovenensstemmelseklæring Declaração de conformidad Vastavusdeklaratsioon Déclaration de conformité	Декларация за съответствие Діахон оцпорфюноц Megfelelőségi nyilatkozat Dichiarazione di conformità Izjava o skladnosti Vaatumustenmukaisuusvakuutus	Deklaracja zgodności Declaratie de conformitate Declaração de conformidade Försäkran om överensstämmelse Izjava o skladnosti Vaatumustenmukaisuusvakuutus	
Manufacturer: / Выговец / Hersteller / Fabrikant / Fabricante / Tootja / Fabricant / Производитель / Κατασκευαστής / Gyártó / Fabricante / Fabricant / Producent / Fabricante / Producent / Produttore / Производитель / Tilvekkare / Proizvajalec / Valmistaja	Numatic International Limited Chard Somerset TA20 2GB www.numatic.co.uk NPR, NR	Numatic International Limited Chard Somerset TA20 2GB www.numatic.co.uk NPR, NR	
Product: / Produkt / Product / Produkt / Producto, Toode, Produkt / Продукт / Προϊόν / Termék / Prodotto / Produkta / Artikel / Produkt / Produkto / Produkt / Товар / Produkt / Izdelka / Tuote: / Products / Produkt / Produit / Product / Producto, Toode, Produkt / Produkto / Produkt / Товар / Produkt / Izdelka / Tuote:			
Description: / Opis / Beschreibung / Beskrivelse / Descripción / Kirjeldus / La description / Описание / Περιγραφή / Leirás / Descricione / Apibūdinimas / Omschrijving / Beskrivelse / Descrição / Opis / Descrriere / Описание / Beskrivning / Opis / Kuvaus:			
GB We, Numatic hereby declare under our sole responsibility, that the above-mentioned product(s) is/are in conformity with the following directives and standards.	BG Ние, Numatic с настоящото декларираме на своя лична отговорност, че посочените по-горе продукти е в съответствие със следните директиви и стандарти.	PT Nós, a Numatic declaramos, sob nossa exclusiva responsabilidade, que o produto acima mencionado está em conformidade com as diretrizes e normas a seguir.	
CZ My, Numatic prohlašujeme na svou výlučnou odpovědnost, že výše uvedené výrobky je ve shodě s následujícími směrniciemi a normami.	GR Εγείς, Numatic δηλώνουμε με αποκλειστική μας ευθύνη, ότι το προαναφερόμενο προϊόν συμμορφώνεται με τις ακόλουθες οδηγίες και πρότυπα.	PL My, Numatic Niniejszym oświadczamy z pełną odpowiedzialnością, że wyżej wymieniony produkt jest zgodny z następującymi dyrektywami i normami.	
DE Wir, Numatic erklären in alleiniger Verantwortung, dass das oben genannte Produkt den folgenden Richtlinien und Normen entspricht.	HU Mi, Numatic kijelentjük, egyedül felelősséggel, hogy a fent említett termék megfelel az alábbi irányelveknek és szabványoknak	RO Noi, Numatic Prin prezenta declaram pe propria răspundere, că produsul mai sus menționat este în conformitate cu următoarele standarde și directive.	
DK Vi, Numatic erklærer hermed under eget ansvar at ovennævnte produkt(er) er i overensstemmelse med følgende direktiver og standarder.	IT Noi, Numatic dichiariamo sotto la propria responsabilità, che il prodotto di cui sopra è conforme alle seguenti direttive e norme.	RU Мы, Нифииск овим, изьявляем под личном одговорношћу, да наведенор производ је у складу са следяћим директивама и стандардима.	
ES Nosotros, Numatic declaramos bajo nuestra única responsabilidad que el producto antes mencionado está en conformidad con las siguientes directivas y normas	LT Mes, "Numatic" pareiškiu vieną aiškios atsakomybės, kad pirmiau minėtas produktas atitinka šias direktyvas ir standartus	SE Vi Numatic förklarar härmed under eget ansvar att ovan nämnda produkt överensstämmer med följande direktiv och normer.	
EE Meie, Numatic käesolevaga kinnitame ja kanname ainuühtlulist vastutust, et eespool nimetatud toode on kooskõlas järgmistega direktiivide ja	NL We verklaren Numatic hierbij op eigen verantwoordelijkheid, dat het bovengenoemde product voldoet aan de volgende richtlijnen en normen	SI Mi, Numatic izjavljamo s polno odgovornostjo, da je zgoraj omenjeni izdelek v skladu z naslednjimi smernicami in standardi.	
FR Numatic déclare sous notre seule responsabilité que le produit mentionné ci-dessus est conforme aux directives et normes suivantes.	NO Vi, Numatic erklærer herved under eget ansvar, at det ovennevnte produktet er i samsvar med følgende direktiver og standarder	FI Me, Numatic täten vakutamme omalla vastuulla, että edellä mainittu tuote on yhdenmukainen seuraavien direktiivien ja standardien mukaisesti	

2006/42/EC

Machinery Directive

EN60335-1:2012 + AC:2014 + A11:2014 + A13:2017 + A15:2021
EN60335-2-67:2012
EN62233:2008

2014/30/EU

EMC Directive

EN55014-1:2017 + A11:2020
EN55014-2:1997 + A1:2001 + A2:2008
EN61000-3-2:2014
EN61000-3-3:2013

2011/65/EU

RoHS Directive

Authorised Signatory: Mr. Matthew Coles

Signed: *M Coles* Date: 17th August 2023

Position: Head of Technology

Numatic International Limited
Chard,
Somerset, TA20 2GB, UK

DEC-057 V3.2

This Machine Has Been Packed
With The Following

Signed

Distributed by:

Numatic

numatic.com

Numatic International Limited.
Chard, Somerset TA20 2GB ENGLAND
Tel: 01460 68600 www.numatic.co.uk

Numatic International GmbH. Fränkische Straße 15–19
D-30455 Hannover, DEUTSCHLAND
Tel: 05 11 98 42 16 0 www.numatic.de

Numatic International SAS. 13 / 17 rue du Valengelier
EAE La Tuilerie, 77500 CHELLES, FRANCE
Tel: 01 64 72 61 61 www.numatic.fr

Numatic International BV, Vennootsweg 15
2404 CG, Alphen aan den Rijn, Nederland
Tel: 0172 467 999 www.numatic.nl

Numatic International (Pty.) Ltd.
16th & Pharmaceutical Roads, Midrand, Gauteng,
SOUTH AFRICA 1685
Tel: 0861 686 284 www.numatic.co.za

Numatic International Schweiz AG.
Sihlbruggstrasse 3A, 6340 Baar. SCHWEIZ
Tel: 0041 (0) 41 76 80 76 - 0 www.numatic.ch

Numatic International ULDA. Rua da Boa Viagem, 177
4470.210 Maia. PORTUGAL
Tel: +351 220 047 700 www.numatic.pt

Numatic International SLU. C/ La Forja, 41, 08840 Viladecans
(Barcelona), Spain
Tel: +34 93 647 22 22 www.numatic.es

Numatic International Denmark. Fränkische Straße 15-19,
30455 Hannover, DEUTSCHLAND
Tel: +45 (0) 31 64 08 08 info@numatic-online.dk
www.numatic-online.dk

This Product has been comprehensively inspected and checked during every stage of its manufacture.
Including an in-depth electrical safety and functionality test.

Specification subject to change without prior notice
numatic.com © Numatic International Limited
233810 10/23 (A16)