

See juhis on mõeldud kiireks hoolduseks ja puhastamiseks ning ei asenda kasutus- ja hooldusjuhendit. Enne masina kasutamist lugege masina kasutus- ja hooldusjuhend põhjalikult läbi ja järgige täpselt kõiki juhiseid.

ETTEVALMISTUS / KASUTAMINE

1

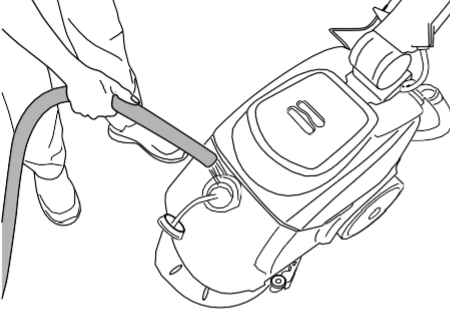

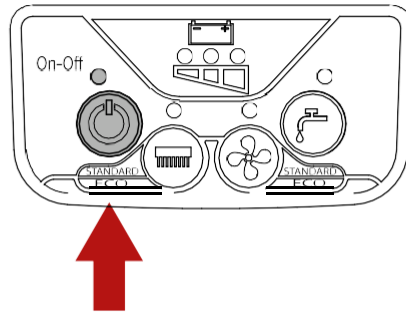

2

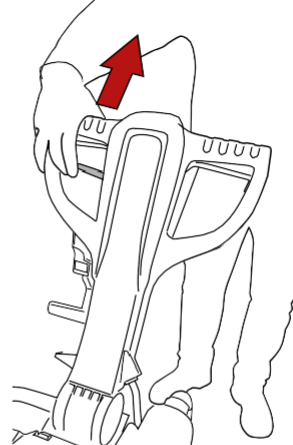

3

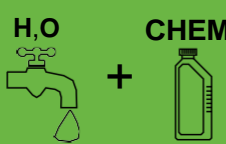







5

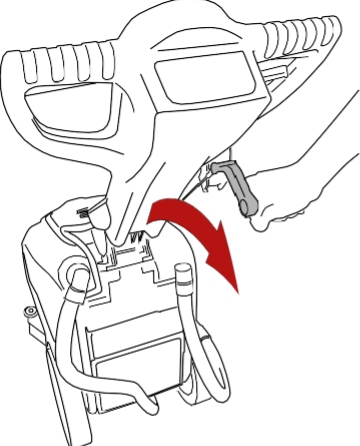

6

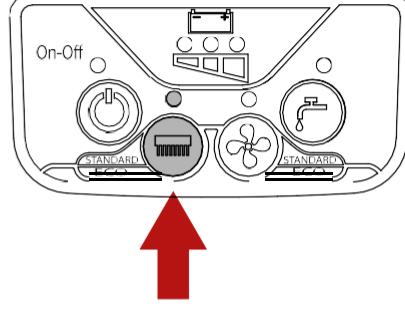

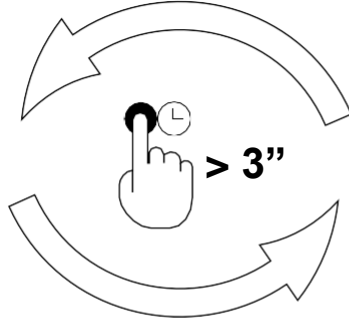

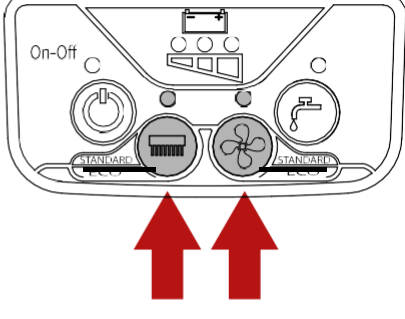



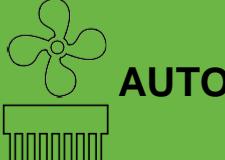



7

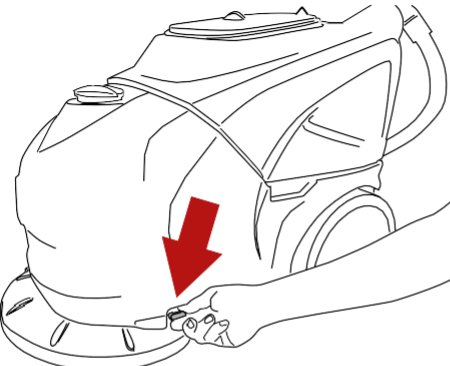

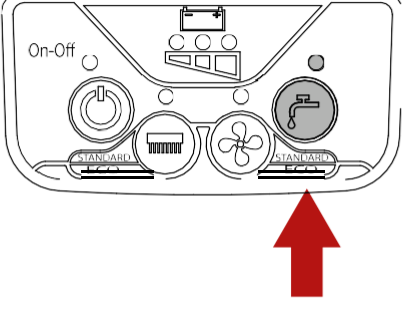

8

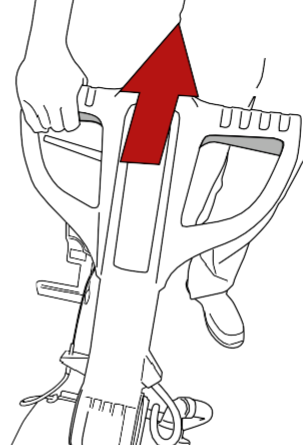

9









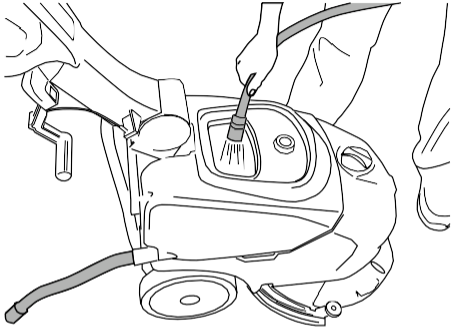
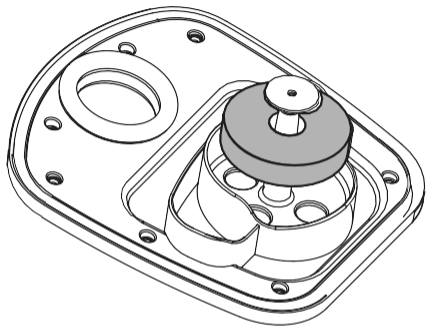
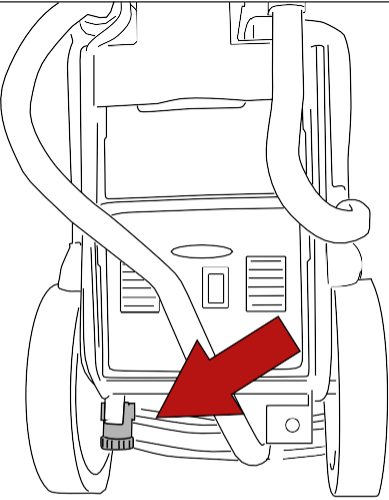
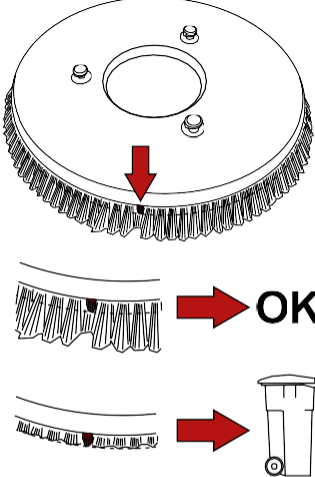

IGAPÄEVANE HOOLDUS

			
<p>Puhasta mustavee paak ja voolikud</p>	<p>Kontrollige, et mustavee paagi ujuk on terve ja puhas ning liigub varda otsas vabalt</p>	<p>Kontrollige, et puhtaveepaagi väljalaskefilter on terve ja puhas</p>	<p>Puhastage hari</p>

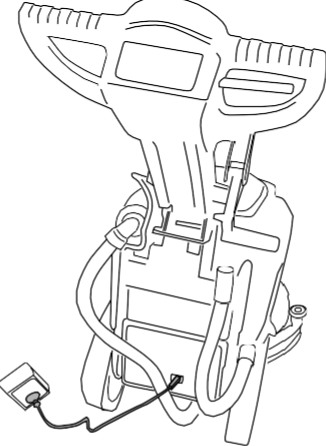
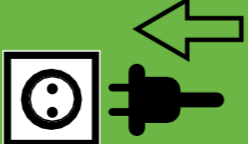
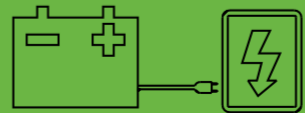
 <p>Kontrollige, et imukummijalg on puhas ja labad ei ole kahjustatud</p>	
 	

Aku laadimiseks ühendage akulaadija, kasutades masina juurde kuuluvat pikendust.

IMUKUMMIDE VAHETAMINE

- Eemaldage imukummid, keerates kahelt imukummi kinnitilt kruvid lahti;
- Pöörake imukummid ümber või asendada uuega (kui imukumm on kõigist neljast servast kulunud)
- Asetage kaks imukummi kinnitit tagasi ja keerake kruvid kinni.

HARJA AUTOMAATNE KINNITAMINE / EEMALDAMINE

Harja kinnitamine:

asetage hari seadme ette põrandale. Tõstke seadme esiosa üles käepidemele toetudes, seejärel laske see alla harja peale, paigutades selle harjakatte keskele. Liigutage veohooba korduvalt harja lukustamiseni.

Harja eemaldamine:

- Tõstke seadme esiosa üles käepidemele toetudes, seejärel liigutage harjahooba korduvalt. Pärast hoova mitmekordset liigutamist, hari vabastatakse ja see kukub põrandale.