

Tämä käyttöohje on tarkoitettu koneen päivittäisten toimintojen opastamiseen eikä korvaa koneen alkuperäistä käyttöohjetta (User and maintenance manual). Tutustu sekä alkuperäisiin käyttöohjeisiin että tähän ohjeeseen ennen koneen käyttöönottoa ja noudata annettuja ohjeita.

This guide is intended for quick consultation only and does not replace the user and maintenance manual. Before using the machine, read the user and maintenance manual contained in the machine's packaging thoroughly and strictly follow all the instructions.

Käesolev juhend on mõeldud ainult kiireks tutvumiseks ja ei asenda kasutus- ega hooldusjuhendit. Enne masina kasutamist lugege põhjalikult masina pakendis olevat kasutus- ja hooldusjuhendit, järgides rangelt kõiki juhiseid.

Ši rokasgrāmata ir paredzēta vienīgi ātrai konsultācijai, tā neaizstāj lietotāja un apkopes rokasgrāmatu. Pirms iekārtas lietošanas uzmanīgi izlasiet ierīces iepakojumā esošo lietotāja un apkopes rokasgrāmatu un stingri ievērojiet visas instrukcijas.

Šis vadovas skirtas tik greitoms konsultācijoms ir nepakeičia īssamaus vartotojo ir priezīuros vadovo. Pries naudodamiesi iřrengimu, atdiziai perskaiykite pakuoteje esanti vartotojo ir priezīuros vadovā ir grieztai laikykites visū instrukciju.

## Pikakäyttöohjeet Quick guide Kiirjuhend Rokasgrāmata Trumpas vadovas

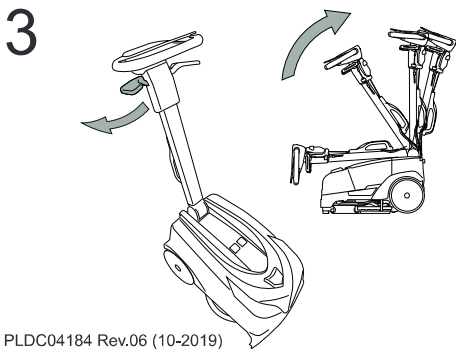
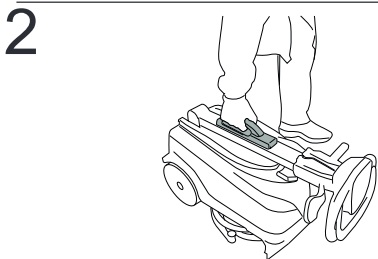
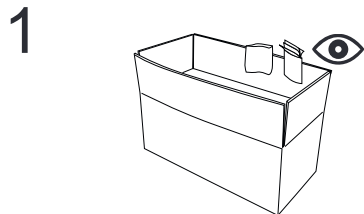

PLDC04184 Rev.06 (10-2019)

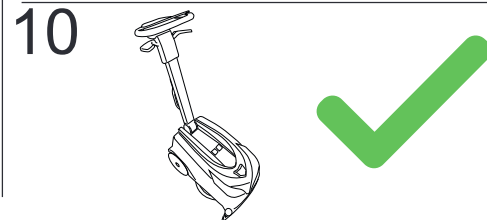
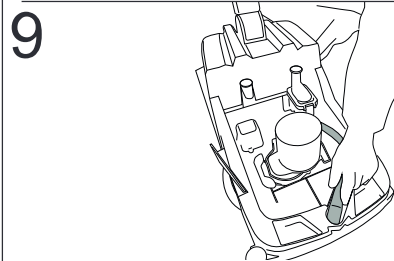
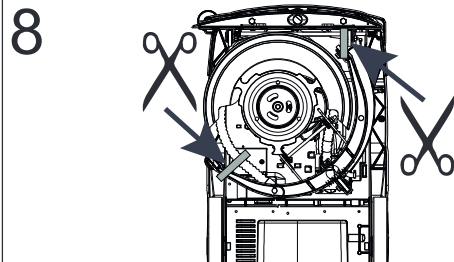
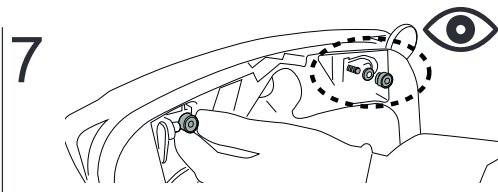
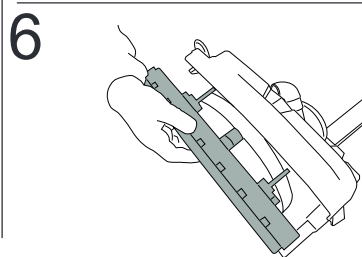
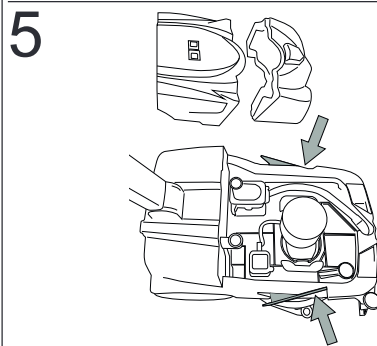
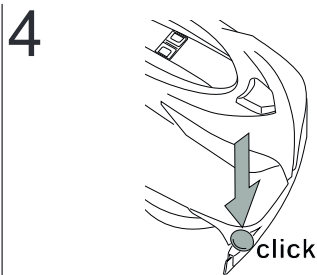

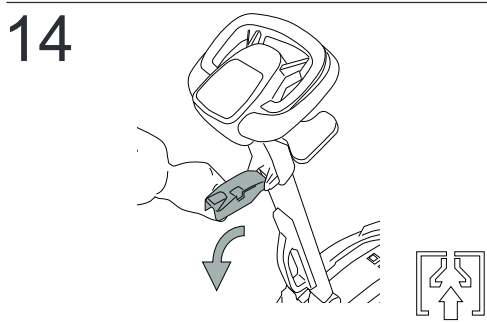
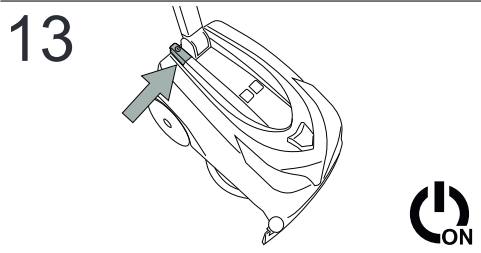
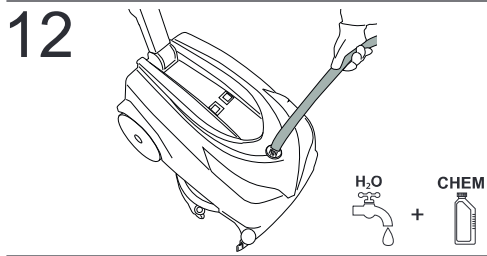
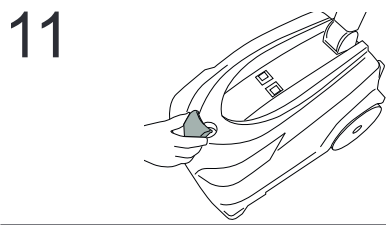

PLDC04184 Rev.06 (10-2019)

